

50/144/430 MHz Triple-Band  
Heavy Duty Submersible Transceiver

**VX-7R**

Technical Supplement

©2002 VERTEX STANDARD CO., LTD. Printed in Japan.

EH009M90A

**VERTEX STANDARD CO., LTD.**

4-8-8 Nakameguro, Meguro-Ku, Tokyo 153-8644, Japan

**VERTEX STANDARD**

**US Headquarters**

10900 Walker Street, Cypress, CA 90630, U.S.A.

**International Division**

8350 N.W. 52nd Terrace, Suite 201, Miami, FL 33166, U.S.A.

**YAESU EUROPE B.V.**

P.O. Box 75525, 1118 ZN Schiphol, The Netherlands

**YAESU UK LTD.**

Unit 12, Sun Valley Business Park, Winnall Close  
Winchester, Hampshire, SO23 0LB, U.K.

**VERTEX STANDARD HK LTD.**

Unit 5, 20/F., Seaview Centre, 139-141 Hoi Bun Road,  
Kwun Tong, Kowloon, Hong Kong



**Introduction**

This manual provides the technical information necessary for servicing the VX-7R 50/144/430 MHz Triple-Band Heavy Duty Submersible Transceiver.

Servicing this equipment requires expertise in handling surface-mount chip components. Attempts by non-qualified persons to service this equipment may result in permanent damage not covered by the warranty, and may be illegal in some countries.

Two PCB layout diagrams provided for each double-sided board in this transceiver. Each side of the board is referred to by the type of the majority of components installed on that side ("Side A" or "Side B"). In most cases one side has only chip components, and the other has either a mixture of both chip and leaded components (trimmers, coils, electrolytic capacitors, ICs, etc.), or leaded components only.

While we believe the information in this manual to be correct, VERTEX STANDARD assumes no liability for damage that may occur as a result of typographical or other errors that may be present. Your cooperation in pointing out any inconsistencies in the technical information would be appreciated.

**Contents**

<b>Specification .....</b>	<b>2</b>
<b>Exploded View &amp; Miscellaneous Parts .....</b>	<b>4</b>
<b>Block Diagram .....</b>	<b>5</b>
<b>Interconnection Diagram .....</b>	<b>6</b>
<b>Circuit Description .....</b>	<b>7</b>
<b>Alignment .....</b>	<b>11</b>
<b>Board Unit (Schematics, Layouts &amp; Parts)</b>	
RF Unit .....	19
AF Unit .....	33
CNTL Unit .....	43
VCO Unit .....	53

# Specifications

## General

### Frequency Ranges:

#### Rx (MAIN):

0.5 - 1.8 MHz (BC Band)  
1.8 - 30 MHz (SW Band)  
30-59 MHz (50 MHz HAM: USA version)  
30-76 MHz (50 MHz HAM: EXP version)  
59-108 MHz (FM: USA version)  
76-108 MHz (FM: EXP version)  
108-137 MHz (Air Band)  
137-174 MHz (144 MHz HAM)  
174-222 MHz (VHF-TV)  
222-225 MHz (220 MHz HAM: USA version)  
225-420 MHz (ACT1: Action Band 1: USA version)  
222-420 MHz (ACT1: Action Band 1: EXP version)  
420-470 MHz (430 MHz HAM)  
470-729 MHz (UHF-TV: USA version)  
470-800 MHz (UHF-TV: EXP version)  
800-999 MHz (ACT2: Action Band 2, cellular Blocked)

#### Rx (SUB):

50 - 54 MHz  
137 - 174 MHz  
420 - 470 MHz

#### Tx: 50 - 54 MHz (MAIN & SUB)

144 - 146 MHz or 144 - 148 MHz (MAIN & SUB)  
222-225 MHz (MAIN, USA version)  
430 - 440 MHz or 430 - 450 MHz (MAIN & SUB)

### Channel Steps:

5/9/10/12.5/15/20/25/50/100 kHz

### Frequency Stability:

±5 ppm (+14°F to +122°F, -10°C to +50°C)

### Emission Type:

F2, F3, A3

### Antenna Impedance:

50-ohm

### Supply Voltage:

Nominal: 7.4 V DC, Negative Ground

Operating: 10 - 16 V DC, Negative Ground (EXT DC jack)

### Current Consumption:

150 mA (Mono Band Receive)

200 mA (Dual Band Receive)

55 mA (Mono Band Receive, Standby, Saver Off)

100 mA (Dual Band Receive, Standby, Saver Off)

25 mA (Mono Band Receive, Standby, Saver On "Save Ratio 1:5")

50 mA (Dual Band Receive, Standby, Saver On "Save Ratio 1:5")

400 µA (Auto Power Off)

1.6/1.3/1.0/0.7 A (50 MHz, Tx HI/L3/L2/L1)

1.71.4/1.1/0.8 A (144 MHz, Tx HI/L3/L2/L1)

0.6 A (220 MHz, Tx)

1.8/1.5/1.2/0.9/ A (430 MHz, Tx HI/L3/L2/L1)

### Operating Temperature:

-4°F to +140°F (-20°C to +60°C)

### Case Size:

60 (W) x 90 (H) x 28 (D) mm (w/o knob & antenna)

### Weight:

250 g

## **Transmitter**

<b>RF Power Output:</b>	5/2.5/1.0/0.5 W (50/144/430 MHz, FM) 0.3 W (220 MHz, FM) 1.0 W (50 MHz, FM)
<b>Modulation Type:</b>	FM: Variable Reactance AM: Early Stage (Low Level)
<b>Maximum Deviation:</b>	$\pm 5/\pm 2.5$ kHz
<b>Spurious Emission:</b>	At least 60 dB below (@ Tx 1W)
<b>Microphone Impedance:</b>	2 k-ohm

## **Receiver**

<b>Circuit Type:</b>	N-FM, AM: Double-Conversion Superheterodyne W-FM: Triple-Conversion Superheterodyne
<b>Intermediate Frequencies:</b>	1st: 47.25 MHz (N-FM, AM) 45.8 MHz (W-FM) 2nd: 450 kHz (N-FM, AM) 10.7 MHz (W-FM) 3rd: 1 MHz (W-FM)
<b>Sensitivity:</b>	3.0 $\mu$ V for 10 dB SINAD (0.5 - 30 MHz, AM) 0.5 $\mu$ V for 12 dB SINAD (30 - 50 MHz, N-FM) 0.16 $\mu$ V for 12 dB SINAD (50 - 54 MHz, N-FM) 15 kHz/35 kHz (-6 dB/-60 dB: N-FM, AM)
<b>Selectivity:</b>	200 kHz/300 kHz (-6 dB/-20 dB: W-FM)
<b>AF Output:</b>	200 mW @ 8 ohm for 10 % THD (@ 7.4V DC) 400 mW @ 8 ohm for 10 % THD (@ 13.8V DC)

***Specifications are subject to change without notice, and are guaranteed within amateur bands only.***

# Exploded View & Miscellaneous Parts

No.	VXSTD P/N	DISCRIPTION	QTY.
①	U9900137	BINDING HEAD SCREW M2X21.7 (W/O RING)	2
②	U9900138	BINDING HEAD SCREW M2X5 (W/O RING)	4
③	U07225120	PAN HEAD SCREW M2X2.5SUS#1	4
④	U9900136	SPECIAL SCREW M2X2.35	1
⑤	RA0304300	WASHER	1
⑥	U00103002	PAN HEAD SCREW M2X3NI	1
⑦	U00104002	PAN HEAD SCREW M2X4NI	6
⑧	U9900140	TAPTITE SCREW M2X6SUS#3	2
⑨	U44104002	TAPTITE SCREW M2X4NI	4
⑩	U9900141	TAPTITE SCREW M1.7X5NI#3	2
⑪	U07125102	TAPTITE SCREW M1.7X2.5SUS#1	2

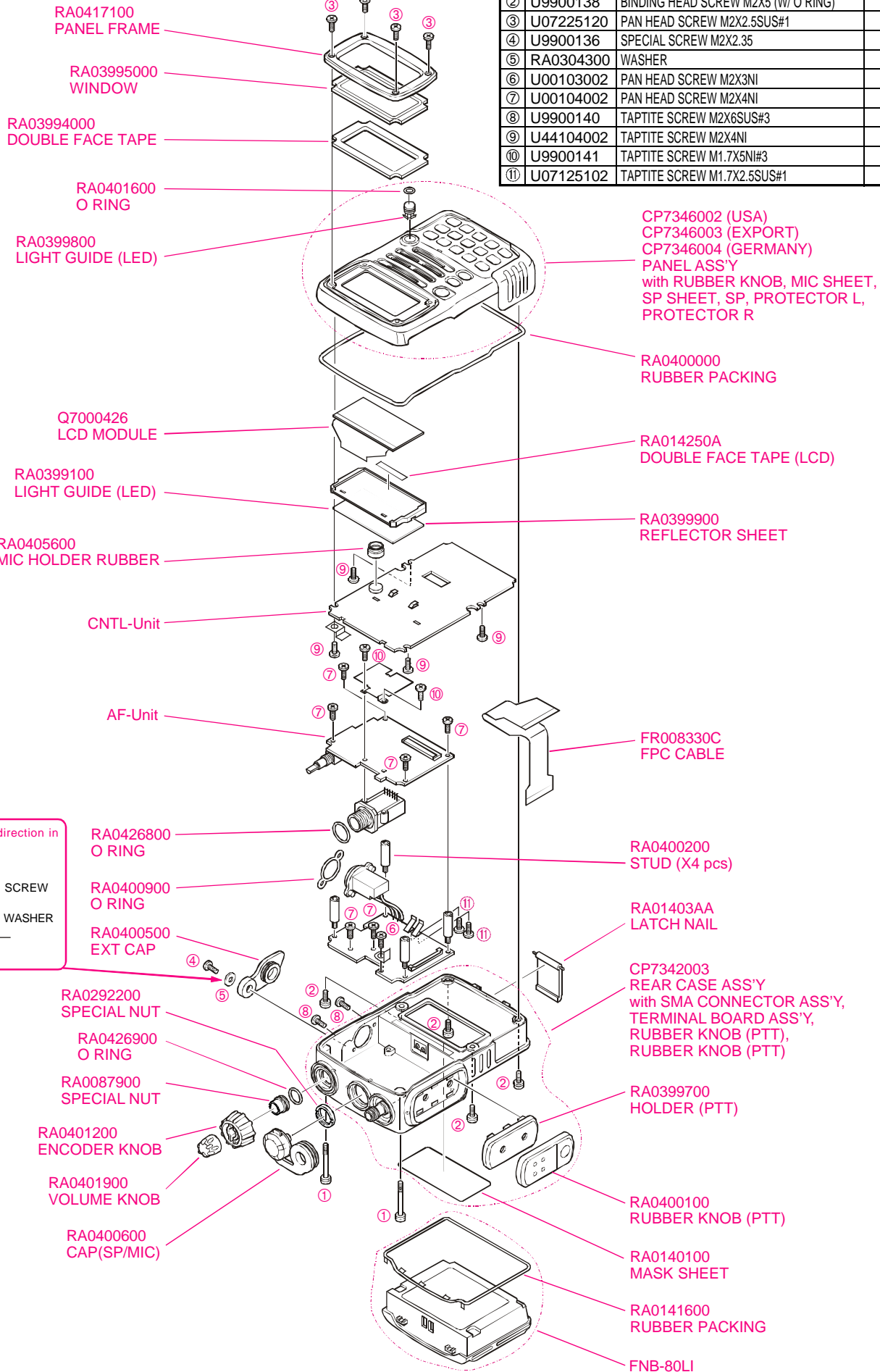
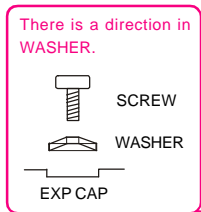



# Block Diagram

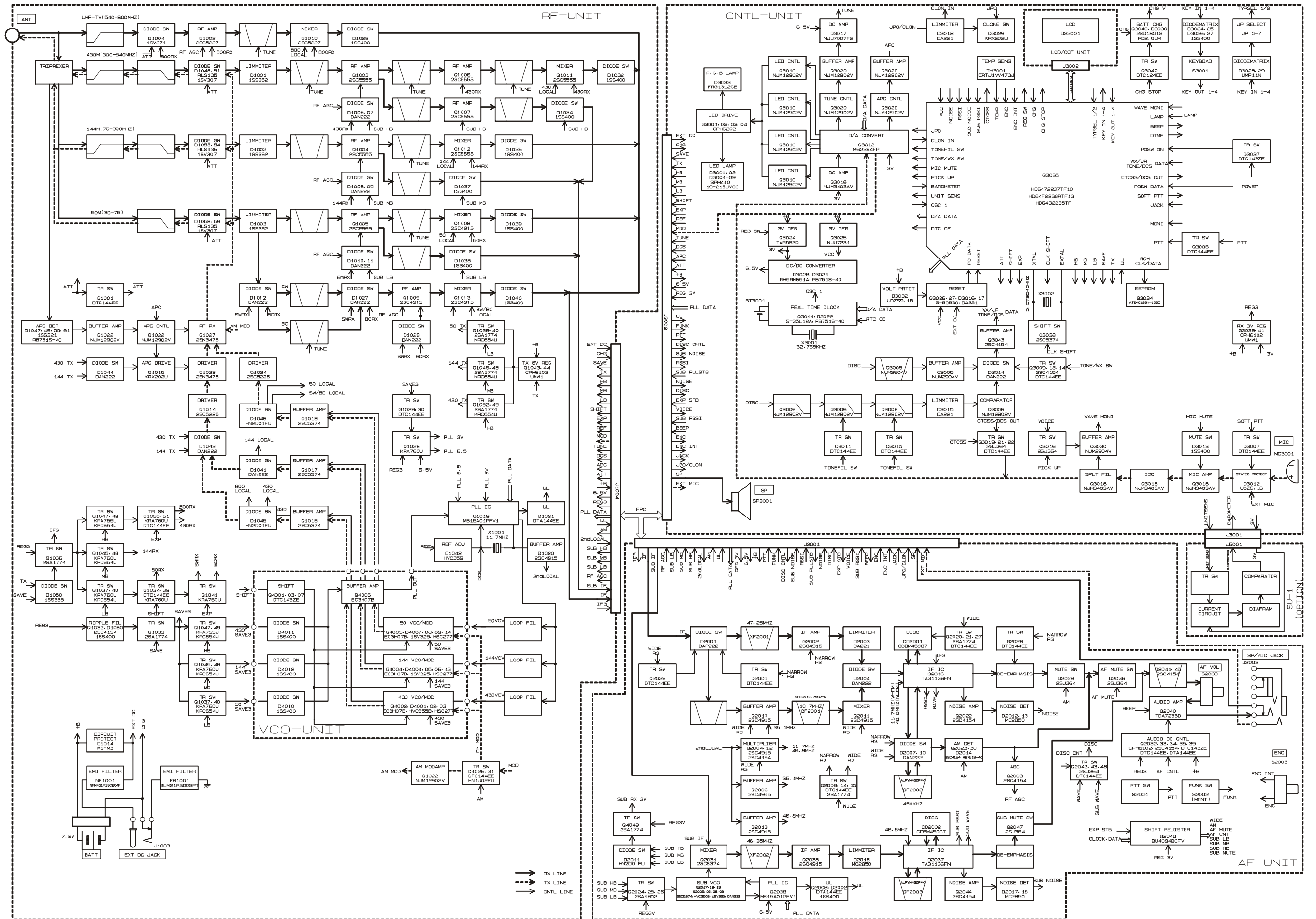

# Interconnection Diagram

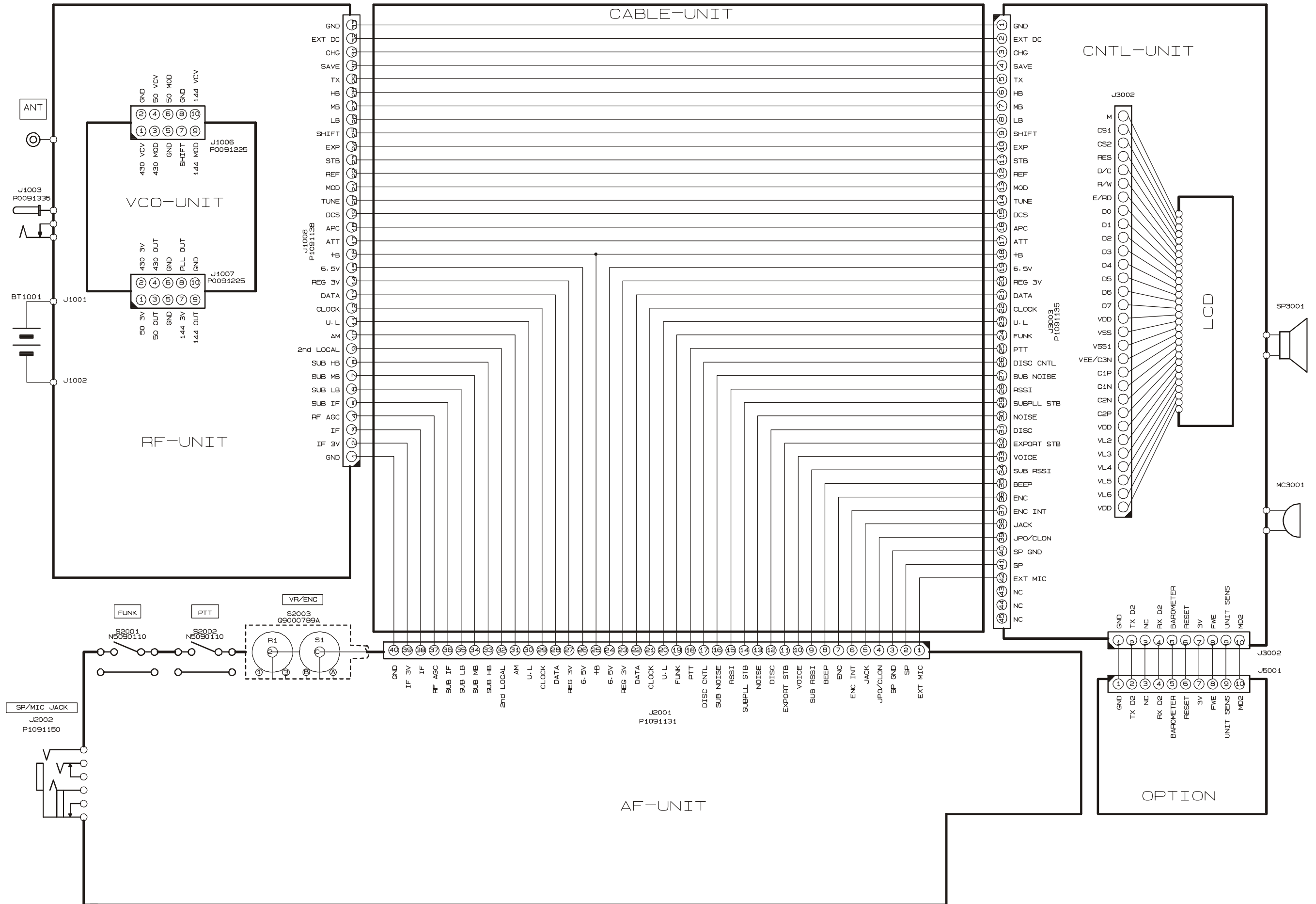

# Circuit Description

The VX-7R consists of a RF-UNIT, a CNTL-UNIT and an AF-UNIT. The RF-UNIT contains the receiver front end, PLL IC, power and switching circuits, and the VCO-UNIT for transmit and receive local signal oscillation. The CNTL-UNIT contains the CPU, and audio ICs, and the power circuitry for the LCD. The AF-UNIT contains the IF, and audio ICs.

## Receiver Signal Flow

The VX-7R includes five receiver front ends, each optimized for a particular frequency range and mode combination.

### (1) Triplexer

Signals between 0.5 and 540 MHz received at the antenna terminal pass through a first low-pass filter composed of C1266, C1269, C1289, C1291, C1296, C1297, L1059, L1060, L1067 and L1068.

Received 430-MHz signals, after passing through the low-pass filter, are fed to the UHF T/R switch circuit composed of diode switch D1048 (RLS135), D1051 (1SV307).

Received 145-MHz signals, after passing through the low-pass filter, are fed to the VHF T/R switch circuit composed of diode switch D1053 (RLS135), D1054 (1SV307).

Received 50-MHz signals, after passing through the low-pass filter, are fed to the 50MHz T/R switch circuit composed of diode switch D1058 (RLS135), D1059 (1SV307).

### (2) 145-MHz Band and 76-300MHz Reception

Received signals between 76 and 300 MHz pass through the Triplexer circuit, low-pass filter/high-pass filter circuit, VHF T/R switch circuit and protector diode D1002 (1SS362) before additional filtering by a band-pass filter prior to application to RF amplifier Q1004 (2SC5555). The amplified RF signal is passed through a band-pass filter to first mixer Q1012 (2SC5555). Meanwhile, VHF output from the VCO-UNIT is amplified by Q1017 (2SC5374) and applied through diode T/R switch D1041 (DAN222) to mixer Q1012 as the first local signal.

The 47.25-MHz intermediate frequency product of the mixer is delivered to the AF-UNIT.

The TUNE voltage from the CPU on the CNTL-UNIT is amplified by DC amplifier Q3017 (NJU7007F2) and applied to varactors D1020 and D1022 (HVC369B), D1019, D1021, D1023, D1024, D1033 and D1036 (1SV325) in the variable frequency band-pass filters. By changing the electrostatic capacitance of the varactors, optimum

filter characteristics are provided for each specific operating frequency.

### (3) 435-MHz Band and 222-540MHz Reception

Received signals between 222 and 540 MHz pass through the Triplexer circuit, low-pass filter/high-pass filter circuit, UHF T/R switch circuit and protector diode D1001 (1SS362) before additional filtering by a band-pass filter prior to application to RF amplifier Q1003 (2SC5555). The amplified RF signal is passed through a band-pass filter, RF amplifier Q1006 (2SC5555) and band-pass filter to first mixer Q1011 (2SC5555). Meanwhile, UHF output from the VCO-UNIT is amplified by Q1016 (2SC5374) and applied through diode T/R switch D1045 (HN2D01FU) to mixer Q1011 as the first local signal.

The 47.25-MHz intermediate frequency product of the mixer is delivered to the AF-UNIT.

The TUNE voltage from the CPU on the CNTL-UNIT is amplified by DC amplifier Q3017 and applied to varactors D1005, D1018, D1030 and D1031 (HVC358B) in the variable frequency band-pass filters. By changing the electrostatic capacitance of the varactors, optimum filter characteristics are provided for each specific operating frequency.

### (4) 50-MHz-Band and 30-76 MHz Reception

Received signals between 30 and 76 MHz pass through the Triplexer circuit, low-pass filter circuit, 50 MHz T/R switch circuit and protector diode D1003 (1SS362) before additional filtering by a band-pass filter prior to application to RF amplifier Q1005 (2SC5555). The amplified RF signal is passed through a band-pass filter to first mixer Q1008 (2SC5555). Meanwhile, 50 MHz output from the VCO-UNIT is amplified by Q1018 (2SC5374) and applied through diode T/R switch D1046 (HN2D01FU) to mixer Q1008 as the first local signal.

The 47.25-MHz intermediate frequency product of the mixer is delivered to the AF-UNIT.

The TUNE voltage from the CPU on the CNTL-UNIT is amplified by DC amplifier Q3017 and applied to varactors D1025 and D1026 (1SV325) in the variable frequency band-pass filters. By changing the electrostatic capacitance of the varactors, optimum filter characteristics are provided for each specific operating frequency.

# Circuit Description

## (5) 0.5 - 30 MHz Reception

Received signals between 0.5 and 30 MHz pass through the Triplexer circuit, low-pass filter circuit, HF T/R switch circuit and protector diode D1003 before additional filtering by a band-pass filter prior to application to RF amplifier Q1009 (**2SC4915-0**). The amplified RF signal is passed through a band-pass filter to first mixer Q1013 (**2SC4915-0**). Meanwhile, HF output from the VCO-UNIT is amplified by Q1018 and applied through diode T/R switch D1046 to mixer Q1013 as the first local signal.

The 47.25-MHz intermediate frequency product of the mixer is delivered to the AF-UNIT.

The TUNE voltage from the CPU on the CNTL-UNIT is amplified by DC amplifier Q3017 and applied to varactors D1013 (**HVR100**) in the variable frequency band-pass filters. By changing the electrostatic capacitance of the varactors, optimum filter characteristics are provided for each specific operating frequency.

## (6) 540 - 999 MHz Reception

Received signals between 540 and 999 MHz pass through the high-pass filter circuit, T/R switch D1004 (**1SV271**) prior to application to RF amplifier Q1002 (**2SC5277**). The amplified RF signal is passed through a band-pass filter to first mixer Q1010 (**2SC5277**). Meanwhile, UHF output from the VCO-UNIT is amplified by Q1016 and applied through diode T/R switch D1045 to mixer Q1010 as the first local signal.

The 47.25-MHz intermediate frequency product of the mixer is delivered to the AF-UNIT.

The TUNE voltage from the CPU on the CNTL-UNIT is amplified by DC amplifier Q3017 and applied to varactors D1015 and D1017 (**HVC355B**) in the variable frequency band-pass filters. By changing the electrostatic capacitance of the varactors, optimum filter characteristics are provided for each specific operating frequency.

## (7) 47.25-MHz First Intermediate Frequency

The 47.25-MHz first intermediate frequency from the first mixers is delivered from the RF-UNIT to the AF-UNIT through jacks J1008 and J2001. On the AF-UNIT, the IF for AM and FM-narrow signals is passed through NAR/WIDE switch D2001 (**DAP222**) and the 47.25-MHz monolithic crystal filter (MCF) XF2001 to narrow IF amplifier Q2002 (**2SC4915-0**) for input to pin 16 of the Narrow IF IC Q2016 (**TA31136FN**), after amplitude limiting by D2003 (**DA221**).

Meanwhile, a portion of the output of 11.7-MHz crys-

tal X1001 on the RF-UNIT is multiplied fourfold by Q2004 (**2SC4915-0**) and Q2012 (**2SC4154E**) to provide the 46.8-MHz second local signal, applied to the Narrow IF IC. Within the IC, this signal is mixed with the 47.25-MHz first intermediate frequency signal to produce the 450 kHz second intermediate frequency.

This second IF is filtered by ceramic filter CF2002 (**ALFYM450F=k**) and amplified by the limiting amplifier within the Narrow IF IC before quadrature detection by ceramic discriminator CD2001 (**CDBM450C7**).

Demodulated audio is passed from pin 9 of the Narrow IF IC through the "Mute" analog switch Q2029 (**2SJ364**) and squelch gate Q2036 (**2SJ364**) before de-emphasis at Q2028 (**DTC144EE**).

The resulting audio is amplified by AF amplifier Q2040 (**TDA7233D**) and fed through the MIC/EAR jack J2002 to internal speaker SP1001 or an external earphone.

## (8) Squelch Control

Signal components in the neighborhood of 15 kHz contained in the discriminator output pass through an active band-pass filter composed of R2059, R2060, R2062, C2076, C2078 and the operational amplifier between pins 7 and 8 within Narrow IF IC Q2016. They are then rectified by D2012 and D2013 (**MC2850**) to obtain a DC voltage corresponding to the level of noise. This voltage is fed to pin 49 of CPU Q3035 (**HD6472237TF10**), which compares the input voltage with a previously set threshold. When the input voltage drops below the threshold, normally due to the presence of a carrier, the CPU turns on squelch gate Q2036 and allows any demodulated audio to pass. At the same time, Q3001 and/or Q3003 and/or Q3004 goes on, causing the BUSY/TX lamp D3033 (**FRGB1312CE-10-TF**) to light.

## Transmitter Signal Flow

### (1) 145-MHz-Band Transmit/Receive Switching

Closing PTT switch S2002 on the AF-UNIT pulls the base of Q3008 (**DTA144EE**) low, causing the collector to go high. This signal is fed to pin 33 (PTT) of CPU Q3035, allowing the CPU to recognize that the PTT switch has been pushed. When the CPU detects closure of the PTT switch, pin 10 (TX) goes high. This control signal is delivered to the RF-UNIT, where it switches Q1044 (**UMW1**) and Q1043 (**CPH6102**) to produce the TX control signal that activates Q1046 (**2SA1774**). At the same time, PLL division data is fed to PLL IC Q1019 (**MB15A01PFV1**) from the CPU, to disable the receiver power saver. Also,

# Circuit Description

it switches Q1048 (**KRC654U**) to disable the receiver circuits. This causes the "red" mode of BUSY/TX lamp D3033 to light.

## **(2) Modulation**

Voice signal input from either built-in microphone MC3001 (**EM-140**) on the CNTL-UNIT or external jack J2002 on the AF-UNIT is pre-emphasized by C3012 and R3031, and processed by microphone amplifier Q3018 (**NJM3403AV**), IDC (instantaneous deviation control) circuit Q1014 to prevent overmodulation, and fed through active low-pass filter Q1014.

During CTCSS operation, the voice signal is mixed with the TONE ENC subaudible tone signal from pin 43 of the CPU and delivered to the RF-UNIT through jacks J3003 and J1008. During DTMF operation, the DTMF tones from pin 44 of the CPU are fed to the IDC stage.

## **(3) 145-MHz-Band Transmission**

Modulating audio from the CNTL-UNIT passes through deviation setting D/A converter Q3012 to the VHF modulator portion of the VCO-UNIT mounted on the RF-UNIT. This signal is applied to varactor D4005 (**HSC277**) in the tank circuit of VHF VCO Q4004 (**EC3H07B**), which oscillates at the desired VHF transmitting frequency. The modulated VCO signal is buffered by amplifier Q4006 (**EC3H07B**) and Q1017 and delivered through VHF T/R diode switch D1041 to the RF-UNIT. The modulated low-level VHF transmit signal from the VCO is passed through diode switch D1043 (**DAN222**) to amplifier Q1014 (**2SC5226-5**). The modulated VHF transmit signal from the VCO is amplified by Q1023 (**2SK3475**) and RF power amplifier Q1027 (**2SK3476**) up to 0.05, 1.0, 2.5 or 5 Watts (depending on the power source). The RF output passes through TX diode switch D1053. RF output is passed by the T/R switch and low-pass filter to suppress harmonics and spurious products before output gets to the antenna at the antenna terminal.

## **(4) 435-MHz-Band Transmission**

Modulating audio from the CNTL-UNIT passes through deviation setting D/A converter Q3012 to the UHF modulator portion of the VCO-UNIT mounted on the RF-UNIT. This signal is applied to varactor D4002 (**HSC277**) in the tank circuit of UHF VCO Q4002 (**EC3H07B**), which oscillates at the desired UHF transmitting frequency. The modulated VCO signal is buff-

ered by amplifier Q4006 and Q1016 and delivered through UHF T/R diode switch D1045 to the RF-UNIT. The modulated low-level UHF transmit signal from the VCO is passed through diode switch D1045 (**HN2D01FU**) to amplifier Q1014. The modulated UHF transmit signal from the VCO is amplified by Q1023 and RF power amplifier Q1027 up to 0.05, 1.0, 2.5 or 5 Watts (depending on the power source). The RF output passes through TX diode switch D1048. RF output is passed through the T/R switch and low-pass filter to suppress harmonics and spurious products before output gets to the antenna at the antenna terminal.

## **(5) 50-MHz-Band Transmission**

Modulating audio from the CNTL-UNIT passes through deviation setting D/A converter Q3012 to the 50 MHz modulator portion of the VCO-UNIT mounted on the RF-UNIT. This signal is applied to varactor D4009 (**HSC277**) in the tank circuit of 50 MHz VCO Q4005 (**EC3H07B**), which oscillates at the desired 50 MHz transmitting frequency. The modulated VCO signal is buffered by amplifier Q4006 and Q1018 and delivered through 50 MHz T/R diode switch D1046 to the RF-UNIT. The modulated low-level 50 MHz transmit signal from the VCO is passed through diode switch D1046 (**HN2D01FU**) to amplifier Q1014. The modulated 50 MHz transmit signal from the VCO is amplified by Q1023 and RF power amplifier Q1027 up to 0.05, 1.0, 2.5 or 5 Watts (depending on the power source). The RF output passes through TX diode switch D1058. RF output is passed through the T/R switch and low-pass filter to suppress harmonics and spurious products before output gets to the antenna at the antenna terminal.

# ***Circuit Description***

## ***PLL Frequency Synthesizer***

PLL IC Q1019 on the RF-UNIT consists of a data shift register, reference frequency divider, phase comparator, charge pump, "intermittent operation" circuit, and band selector switch. Serial PLL data from the CPU is converted into parallel data by the shift register in the PLL IC and is latched into the comparative frequency divider and reference frequency divider to set a frequency dividing ratio for each. An 11.7-MHz reference signal produced by X1001 is fed to "REF" pin 1 of the PLL IC. The internal reference frequency divider divides the 11.7-MHz reference by 2,050 (or 1,640) to obtain a reference frequency of 5 kHz (or 6.25 kHz), which is applied to the phase comparator. Meanwhile, a sample of the output of VHF VCO Q4004 or UHF VCO Q4002 or 50 MHz VCO Q4005 on the VCO-UNIT, buffered by Q4006, is fed to the PLL IC, where it is divided by the internal comparative frequency divider to produce a comparative frequency which also is applied to the phase comparator. The phase comparator compares the phase between the reference frequency and comparative frequency to output

a pulse corresponding to the phase difference between them. This pulse is fed to the charge pump, and the output from the charge pump passes through a loop filter composed of L1044, R1089, C1175, and either R1090, C1192, R1103 and C1195 for VHF, or R1086, C1189, R1102 and C1194 for UHF, or R1091, C1193, R1104 and C1196 for 50 MHz, which convert the pulse into a corresponding smoothed varactor control voltage (VCV). The VCV is applied to varactors D4004 and D4013 (**1SV325**) in the VHF VCO tank circuit, or to varactor D4001 (**HVC355B**) in the UHF VCO tank circuit, or to varactors D4007 and D4008 (**1SV325**) in the 50 MHz VCO, to eliminate any phase difference between the reference frequency and comparative frequency, thus locking the VCO oscillation frequency to the reference crystal. The VCO frequency is determined by the frequency-dividing ratio sent from the CPU to the PLL IC. During receiver power save operation, the PLL circuit operates intermittently to reduce current consumption, for which the "intermittent operation" control circuit reduces the lock-up time.

## Introduction and Precautions

The VX-7R has been carefully aligned at the factory for the specified performance across the specified amateur bands. Realignment should therefore not be necessary except in the event of a component failure. All component replacement and service should be performed only by an authorized VERTEX STANDARD representative, or the warranty policy may be voided.

The following procedures cover the sometimes critical and tedious adjustments that are not normally required once the transceiver has left the factory. However, if damage occurs and some parts are replaced, realignment may be required. If a sudden problem occurs during normal operation, it is likely due to component failure; realignment should not be done until after the faulty component has been replaced.

We recommend that servicing be performed only by authorized VERTEX STANDARD service technicians, who are experienced with the circuitry and fully equipped for repair and alignment. Therefore, if a fault is suspected, contact the dealer from whom the transceiver was purchased for instructions regarding repair. Authorized VERTEX STANDARD service technicians realign all circuits and make complete performance checks to ensure compliance with factory specifications after replacing any faulty components.

Those who do undertake any of the following alignments are cautioned to proceed at their own risk. Problems caused by unauthorized attempts at realignment are not covered by the warranty policy. Also, VERTEX STANDARD must reserve the right to change circuits and alignment procedures in the interest of improved performance, without notifying owners.

Under no circumstances should any alignment be attempted unless the normal function and operation of the transceiver are clearly understood, the cause of the malfunction has been clearly pinpointed and any faulty components replaced, and the need for realignment determined to be absolutely necessary.

## Required Test Equipment

- RF Signal Generator with calibrated output level at 500 MHz
- Deviation Meter (linear detector)
- In-line Wattmeter with 5% accuracy at 500 MHz
- 50-ohm, 10-W RF Dummy Load
- 8-ohm AF Dummy Load
- Regulated DC Power Supply adjustable from 3 to 15 V DC, 3A
- Frequency Counter: 0.2-ppm accuracy at 500 MHz
- AF Signal Generator
- AC Voltmeter
- DC Voltmeter: high impedance
- UHF Sampling Coupler
- SINAD Meter

## Alignment Preparation & Precautions

A 10-W RF dummy load and in-line wattmeter must be connected to the main antenna jack in all procedures that call for transmission, alignment is not possible with an antenna. After completing one step, read the next step to see if the same test equipment is required. If not, remove the test equipment (except dummy load and wattmeter, if connected) before proceeding.

Correct alignment requires that the ambient temperature be the same as that of the transceiver and test equipment, and that this temperature be held constant between 68-86°F (20-30°C). When the transceiver is brought into the shop from hot or cold air, it should be allowed some time to come to room temperature before alignment. Whenever possible, alignments should be made with oscillator shields and circuit boards firmly affixed in place. Also, the test equipment must be thoroughly warmed up before beginning.

*Note: Signal levels in dB referred to in the alignment procedure are based on 0 dBμ=0.5 μV (closed circuit).*

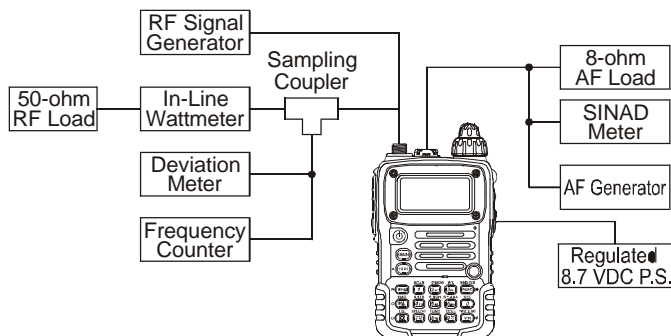

Alignment Setup



# Alignment

## Test Setup

Set up the test equipment as shown below for transceiver alignment, and apply 8.7 V DC power to the transceiver. Refer to the drawings for Alignment Points.

## Internal System Alignment Routine

This uses a programmed routine in the transceiver which simplifies many previously complex discrete component settings and adjustments with digitally-controlled settings via front panel buttons and LCD indications.

To begin, set the transceiver to the center of the 50 MHz, 144 MHz, 222 MHz and 430 MHz bands. Next, select the 430 MHz band, then turn the transceiver off.

Now, press and hold in the **MON/F**, **⊗** and **0** buttons (at the same time) while powering the radio on again. The display will show the first setting. Thereafter, the frequencies used during alignment will automatically be set without action by the technician.

In the alignment process, each adjustment is selected by rotating the **DIAL**. Alignment is performed by:

- Pressing the **V/M** button;
- Injecting a signal of the required frequency and level; then
- Pressing the **V/M** button after a level setting or adjustment is made. This second pressing of the **MON/F** button stores the entry.

To exit the alignment routine, press the **HM/RV** button. After performing the system alignment in its entirety, individual settings can be returned to and adjusted should the need arise.

As each transceiver is individually optimized at the factory, the precise settings for the transceiver on your bench may be slightly different.

## Main Band Alignment

### PLL Reference Frequency (PLL REF)

Press the **V/M** button, then transmit and adjust the counter frequency to 440.000 ( $\pm 300$  Hz) by rotating the **DIAL**, then press the **V/M** button. Rotate the **DIAL** to select the next setting.

## 430 MHz band Alignment

### Squelch Hysteresis Adjustment (HIS SQL)

- Rotate the **DIAL** for minimum squelch hysteresis. Press the **V/M** button, then rotate the **DIAL** to select the next setting.

### Squelch Preset Threshold (THLD SQL) [86]

- Inject a  $-15.0$  dB $\mu$  RF signal (1 kHz tone @  $\pm 3.5$  kHz deviation), then press the **V/M** button, then press the **MON/F** button twice. Press the **V/M** button, then rotate the **DIAL** to select the next setting.

### Squelch Preset Tight (TIGH SQL)

- Adjust the generator level to  $-4.0$  dB $\mu$ , then press the **V/M** button, then press the **MON/F** button twice. Press the **V/M** button, then rotate the **DIAL** to select the next setting.

### S-Meter S-1 Adjustment (S1 LEVEL)

- Adjust the generator level to  $-7.0$  dB $\mu$  (1 kHz tone @  $\pm 3.5$  kHz deviation), then press the **V/M** button, then press the **MON/F** button twice. Press the **V/M** button, then rotate the **DIAL** to select the next setting.

### S-Meter Full-Scale Adjustment (S9 LEVEL)

- Adjust the generator level to  $+20$  dB $\mu$  (1 kHz tone @  $\pm 3.5$  kHz deviation), then press the **V/M** button, then press the **MON/F** button twice. Press the **V/M** button, then rotate the **DIAL** to select the next setting.

### Wide-FM S-Meter S-1 Adjustment (S1 LEVEL)

- Adjust the generator level to 0 dB $\mu$  (1 kHz tone @  $\pm 20$  kHz deviation), then press the **V/M** button, then press the **MON/F** button twice. Press the **V/M** button, then rotate the **DIAL** to select the next setting.

### Wide-FM S-Meter Full-Scale Adjustment (S9 LEVEL)

- Adjust the generator level to  $+20$  dB $\mu$  (1 kHz tone @  $\pm 20$  kHz deviation), then press the **V/M** button, then press the **MON/F** button twice. Press the **V/M** button, then rotate the **DIAL** to select the next setting.

The alignment frequency will now be automatically set to 430.000 MHz.

### High TX Power Adjustment (HI POWER)

- Transmit, and adjust the output power level for 5.0 W ( $\pm 0.3$  W) by rotating the **DIAL**, then press the **V/M** button. Rotate the **DIAL** to select the next setting.

### L3 Tx Power Adjustment (L3 POWER)

- Transmit, and adjust the output power level for 2.5 W ( $\pm 0.2$  W) by rotating the **DIAL**, then press the **V/M** button. Rotate the **DIAL** to select the next setting.

### L2 Tx Power Adjustment (L2 POWER)

- Transmit, and adjust the output power level for 1.0 W ( $\pm 0.1$  W) by rotating the **DIAL**, then press the **V/M** button. Rotate the **DIAL** to select the next setting.



# Alignment

## *L1 Tx Power Adjustment (L1 POWER)*

- Transmit, and adjust the output power level for 50 mW (+50/-30 mW) by rotating the **DIAL**, then press the **V/M** button. Rotate the **DIAL** to select the next setting.

## *TX Deviation Adjustment (MAX DEV)*

- Inject a 1 kHz audio tone at a level of 50 mV (rms) to the MIC jack. Press the **V/M** button, then transmit and adjust the deviation for 4.5 kHz ( $\pm 0.2$  kHz) (USA Version: 4.2 kHz ( $\pm 0.2$  kHz)) by rotating the **DIAL**, then press the **V/M** button. Rotate the **DIAL** to select the next setting.

## *CTCSS Tx Deviation Adjustment (TN 67.0)*

- Press the **V/M** button, then transmit and adjust the deviation for 0.5 kHz (+0.05/-0.1 kHz) by rotating the **DIAL**, then press the **V/M** button. Rotate the **DIAL** to select the next setting.

## *CTCSS Tx Deviation Adjustment (TN 183.5)*

- Press the **V/M** button, then transmit and adjust the deviation for 0.5 kHz ( $\pm 0.1$  kHz) by rotating the **DIAL**, then press the **V/M** button. Rotate the **DIAL** to select the next setting.

## *CTCSS Tx Deviation Adjustment (TN 254.1)*

- Press the **V/M** button, then transmit and adjust the deviation for 0.5 kHz ( $\pm 0.1$  kHz) by rotating the **DIAL**, then press the **V/M** button. Rotate the **DIAL** to select the next setting.

## *DCS Tx Deviation Adjustment (DCS DEV)*

- Press the **V/M** button, then transmit and adjust the deviation for 0.6 kHz ( $\pm 0.1$  kHz) by rotating the **DIAL**, then press the **V/M** button. Rotate the **DIAL** to select the next setting.

Press the **MON/F** to activate the TX Power and Deviation alignment routine.

The alignment frequency will automatically be set to 440.000 MHz (USA Version: 450.000 MHz).

## *High TX Power Adjustment (HI POWER)*

- Transmit, and adjust the output power level for 5.0 W ( $\pm 0.3$  W) by rotating the **DIAL**, then press the **V/M** button. Rotate the **DIAL** to select the next setting.

## *High TX Power Adjustment (L3 POWER)*

- Transmit, and adjust the output power level for 2.5 W ( $\pm 0.2$  W) by rotating the **DIAL**, then press the **V/M** button. Rotate the **DIAL** to select the next setting.

## *High TX Power Adjustment (L2 POWER)*

- Transmit, and adjust the output power level for 1.0 W ( $\pm 0.1$  W) by rotating the **DIAL**, then press the **V/M** button. Rotate the **DIAL** to select the next setting.

## *High TX Power Adjustment (L1 POWER)*

- Transmit, and adjust the output power level for 50 mW (+50/-30 mW) by rotating the **DIAL**, then press the **V/M** button. Rotate the **DIAL** to select the next setting.

## *TX Deviation Adjustment (MAX DEV)*

- Inject a 1 kHz audio tone at a level of 50mV (rms) to the MIC jack. Press the **V/M** button, then transmit and adjust the deviation for 4.5 kHz ( $\pm 0.2$  kHz) (USA Version: 4.2 kHz ( $\pm 0.2$  kHz)) by rotating the **DIAL**, then press the **V/M** button. Rotate the **DIAL** to select the next setting.

## *CTCSS Tx Deviation Adjustment (TN 67.0)*

- Press the **V/M** button, then transmit and adjust the deviation for 0.5 kHz (+0.05/-0.1 kHz) by rotating the **DIAL**, then press the **V/M** button. Rotate the **DIAL** to select the next setting.

## *CTCSS Tx Deviation Adjustment (TN 183.5)*

- Press the **V/M** button, then transmit and adjust the deviation for 0.5 kHz ( $\pm 0.1$  kHz) by rotating the **DIAL**, then press the **V/M** button. Rotate the **DIAL** to select the next setting.

## *CTCSS Tx Deviation Adjustment (TN 254.1)*

- Press the **V/M** button, then transmit and adjust the deviation for 0.5 kHz ( $\pm 0.1$  kHz) by rotating the **DIAL**, then press the **V/M** button. Rotate the **DIAL** to select the next setting.

## *DCS Tx Deviation Adjustment (DCS DEV)*

- Press the **V/M** button, then transmit and adjust the deviation for 0.6 kHz ( $\pm 0.1$  kHz) by rotating the **DIAL**, then press the **V/M** button. Rotate the **DIAL** to select the next setting.

Press the **BAND** button to activate the 50 MHz band internal alignment routine.

The alignment frequency will automatically be set to 52.100 MHz.

## **50 MHz Band Alignment**

### *Squelch Hysteresis Adjustment (HIS SQL)*

- Rotate the **DIAL** for minimum squelch hysteresis. Press the **V/M** button, then rotate the **DIAL** to select the next setting.

# Alignment

## *Squelch Preset Threshold (THLD SQL)*

- Inject a  $-15.0$  dB $\mu$  RF signal (1 kHz tone @  $\pm 3.5$  kHz deviation), then press the **V/M** button, then press the **MON/F** button twice. Press the **V/M** button, then rotate the **DIAL** to select the next setting.

## *Squelch Preset Tight (TIGH SQL)*

- Adjust the generator level to  $-4.0$  dB $\mu$ , then press the **V/M** button, then press the **MON/F** button twice. Press the **V/M** button, then rotate the **DIAL** to select the next setting.

## *S-Meter S-1 Adjustment (S1 LEVEL)*

- Adjust the generator level to  $-7.0$  dB $\mu$  (1 kHz tone @  $\pm 3.5$  kHz deviation), then press the **V/M** button, then press the **MON/F** button twice. Press the **V/M** button, then rotate the **DIAL** to select the next setting.

## *S-Meter Full-Scale Adjustment (S9 LEVEL)*

- Adjust the generator level to  $+19$  dB $\mu$  (1 kHz tone @  $\pm 3.5$  kHz deviation), then press the **V/M** button, then press the **MON/F** button twice. Press the **V/M** button, then rotate the **DIAL** to select the next setting.

## *Wide-FM S-Meter S-1 Adjustment (S1 LEVEL)*

- Adjust the generator level to  $0$  dB $\mu$  (1 kHz tone @  $\pm 20$  kHz deviation), then press the **V/M** button, then press the **MON/F** button twice. Press the **V/M** button, then rotate the **DIAL** to select the next setting.

## *Wide-FM S-Meter Full-Scale Adjustment (S9 LEVEL)*

- Adjust the generator level to  $+20$  dB $\mu$  (1 kHz tone @  $\pm 20$  kHz deviation), then press the **V/M** button, then press the **MON/F** button twice. Press the **V/M** button, then rotate the **DIAL** to select the next setting.

The alignment frequency will now be automatically set to 50.000 MHz.

## *High TX Power Adjustment (HI POWER)*

- Transmit, and adjust the output power level for 5.0 W ( $\pm 0.3$  W) by rotating the **DIAL**, then press the **V/M** button. Rotate the **DIAL** to select the next setting.

## *L3 Tx Power Adjustment (L3 POWER)*

- Transmit, and adjust the output power level for 2.5 W ( $\pm 0.2$  W) by rotating the **DIAL**, then press the **V/M** button. Rotate the **DIAL** to select the next setting.

## *L2 Tx Power Adjustment (L2 POWER)*

- Transmit, and adjust the output power level for 1.0 W ( $\pm 0.1$  W) by rotating the **DIAL**, then press the **V/M** button. Rotate the **DIAL** to select the next setting.

## *L1 Tx Power Adjustment (L1 POWER)*

- Transmit, and adjust the output power level for 50 mW ( $+50/-30$  mW) by rotating the **DIAL**, then press the **V/M** button. Rotate the **DIAL** to select the next setting.

## *TX Deviation Adjustment (MAX DEV)*

- Inject a 1 kHz audio tone at a level of 50mV (rms) to the MIC jack. Press the **V/M** button, then transmit and adjust the deviation for 4.5 kHz ( $\pm 0.2$  kHz) (USA Version: ( $4.2 \pm 0.2$  kHz)) by rotating the **DIAL**, then press the **V/M** button. Rotate the **DIAL** to select the next setting.

## *AM Modulation (AM MOD)*

- Inject a 1 kHz audio tone at a level of 100 mV (rms) to the MIC jack. Press the **V/M** button, then transmit and adjust the modulation for 60% ( $\pm 10\%$ ) by rotating the **DIAL**, then press and hold in the **MON/F** button for one second.

## *CTCSS Tx Deviation Adjustment (TN 67.0)*

- Press the **V/M** button, then transmit and adjust the deviation for 0.5 kHz ( $+0.05/-0.1$  kHz) by rotating the **DIAL**, then press the **V/M** button. Rotate the **DIAL** to select the next setting.

## *CTCSS Tx Deviation Adjustment (TN 183.5)*

- Press the **V/M** button, then transmit and adjust the deviation for 0.5 kHz ( $\pm 0.1$  kHz) by rotating the **DIAL**, then press the **V/M** button. Rotate the **DIAL** to select the next setting.

## *CTCSS Tx Deviation Adjustment (TN 254.1)*

- Press the **V/M** button, then transmit and adjust the deviation for 0.5 kHz ( $\pm 0.1$  kHz) by rotating the **DIAL**, then press the **V/M** button. Rotate the **DIAL** to select the next setting.

## *DCS Tx Deviation Adjustment (DCS DEV)*

- Press the **V/M** button, then transmit and adjust the deviation for 0.6 kHz ( $\pm 0.1$  kHz) by rotating the **DIAL**, then press the **V/M** button. Rotate the **DIAL** to select the next setting.

Press the **MON/F** button to activate the TX Power and Deviation alignment routine.

The alignment frequency will automatically be set to 54.000 MHz.

## *High TX Power Adjustment (HI POWER)*

- Transmit, and adjust the output power level for 5.0 W ( $\pm 0.3$  W) by rotating the **DIAL**, then press the **V/M** button. Rotate the **DIAL** to select the next setting.

## High TX Power Adjustment (L3 POWER)

- Transmit, and adjust the output power level for 2.5 W ( $\pm 0.2$  W) by rotating the **DIAL**, then press the **V/M** button. Rotate the **DIAL** to select the next setting.

## High TX Power Adjustment (L2 POWER)

- Transmit, and adjust the output power level for 1.0 W ( $\pm 0.1$  W) by rotating the **DIAL**, then press the **V/M** button. Rotate the **DIAL** to select the next setting.

## High TX Power Adjustment (L1 POWER)

- Transmit, and adjust the output power level for 50 mW (+50/-30 mW) by rotating the **DIAL**, then press the **V/M** button. Rotate the **DIAL** to select the next setting.

## TX Deviation Adjustment (MAX DEV)

- Inject a 1 kHz audio tone at a level of 50mV (rms) to the MIC jack. Press the **V/M** button, then transmit and adjust the deviation for 4.5 kHz ( $\pm 0.2$  kHz) (USA Version: 4.2 kHz ( $\pm 0.2$  kHz)) by rotating the **DIAL**, then press the **V/M** button. Rotate the **DIAL** to select the next setting.

## AM Modulation (AM MOD)

- Inject a 1 kHz audio tone at a level of 100mV (rms) to the MIC jack. Press the **V/M** button, then transmit and adjust the modulation for 60% ( $\pm 10\%$ ) by rotating the **DIAL**.

## CTCSS Tx Deviation Adjustment (TN 67.0)

- Press the **V/M** button, then transmit and adjust the deviation for 0.5 kHz (+0.05/-0.1 kHz) by rotating the **DIAL**, then press the **V/M** button. Rotate the **DIAL** to select the next setting.

## CTCSS Tx Deviation Adjustment (TN 183.5)

- Press the **V/M** button, then transmit and adjust the deviation for 0.5 kHz ( $\pm 0.1$  kHz) by rotating the **DIAL**, then press the **V/M** button. Rotate the **DIAL** to select the next setting.

## CTCSS Tx Deviation Adjustment (TN 254.1)

- Press the **V/M** button, then transmit and adjust the deviation for 0.5 kHz ( $\pm 0.1$  kHz) by rotating the **DIAL**, then press the **V/M** button. Rotate the **DIAL** to select the next setting.

## DCS Tx Deviation Adjustment (DCS DEV)

- Press the **V/M** button, then transmit and adjust the deviation for 0.6 kHz ( $\pm 0.1$  kHz) by rotating the **DIAL**, then press the **V/M** button. Rotate the **DIAL** to select the next setting.

Press the **BAND** button to activate the 145 MHz band internal alignment routine.

The alignment frequency will automatically be set to 145.100 MHz (USA Version: 146.100 MHz).

## 144 MHz Band Alignment

### Squelch Hysteresis Adjustment (HIS SQL)

- Rotate the **DIAL** for minimum squelch hysteresis. Press the **V/M** button, then rotate the **DIAL** to select the next setting.

### Squelch Preset Threshold (THLD SQL)

- Inject a  $-15.0$  dB $\mu$  RF signal (1 kHz tone @  $\pm 3.5$  kHz deviation), then press the **V/M** button, then press the **MON/F** button twice. Press the **V/M** button, then rotate the **DIAL** to select the next setting.

### Squelch Preset Tight (TIGH SQL)

- Adjust the generator level to  $-4.0$  dB $\mu$ , then press the **V/M** button, then press the **MON/F** button twice. Press the **V/M** button, then rotate the **DIAL** to select the next setting.

### S-Meter S-1 Adjustment (S1 LEVEL)

- Adjust the generator level to  $-7.0$  dB $\mu$  (1 kHz tone @  $\pm 3.5$  kHz deviation), then press the **V/M** button, then press the **MON/F** button twice. Press the **V/M** button, then rotate the **DIAL** to select the next setting.

### S-Meter Full-Scale Adjustment (S9 LEVEL)

- Adjust the generator level to  $+19$  dB $\mu$  (1 kHz tone @  $\pm 3.5$  kHz deviation), then press the **V/M** button, then press the **MON/F** button twice. Press the **V/M** button, then rotate the **DIAL** to select the next setting.

### Wide-FM S-Meter S-1 Adjustment (S1 LEVEL)

- Adjust the generator level to 0 dB $\mu$  (1 kHz tone @  $\pm 20$  kHz deviation), then press the **V/M** button, then press the **MON/F** button twice. Press the **V/M** button, then rotate the **DIAL** to select the next setting.

### Wide-FM S-Meter Full-Scale Adjustment (S9 LEVEL)

- Adjust the generator level to  $+20$  dB $\mu$  (1 kHz tone @  $\pm 20$  kHz deviation), then press the **V/M** button, then press the **MON/F** button twice. Press the **V/M** button, then rotate the **DIAL** to select the next setting.

The alignment frequency will now be automatically set to 144.000 MHz.

# Alignment

## High TX Power Adjustment (HI POWER)

- Transmit, and adjust the output power level for 5.0 W ( $\pm 0.3$  W) by rotating the **DIAL**, then press the **V/M** button. Rotate the **DIAL** to select the next setting.

## L3 Tx Power Adjustment (L3 POWER)

- Transmit, and adjust the output power level for 2.5 W ( $\pm 0.2$  W) by rotating the **DIAL**, then press the **V/M** button. Rotate the **DIAL** to select the next setting.

## L2 Tx Power Adjustment (L2 POWER)

- Transmit, and adjust the output power level for 1.0 W ( $\pm 0.1$  W) by rotating the **DIAL**, then press the **V/M** button. Rotate the **DIAL** to select the next setting.

## L1 Tx Power Adjustment (L1 POWER)

- Transmit, and adjust the output power level for 50 mW (+50/-30 mW) by rotating the **DIAL**, then press the **V/M** button. Rotate the **DIAL** to select the next setting.

## TX Deviation Adjustment (MAX DEV)

- Inject a 1 kHz audio tone at a level of 50mV (rms) to the MIC jack. Press the **V/M** button, then transmit and adjust the deviation for 4.5 kHz ( $\pm 0.2$  kHz) (USA Version: 4.2 kHz ( $\pm 0.2$  kHz)) by rotating the **DIAL**, then press the **V/M** button. Rotate the **DIAL** to select the next setting.

## CTCSS Tx Deviation Adjustment (TN 67.0)

- Press the **V/M** button, then transmit and adjust the deviation for 0.5 kHz (+0.05/-0.1 kHz) by rotating the **DIAL**, then press the **V/M** button. Rotate the **DIAL** to select the next setting.

## CTCSS Tx Deviation Adjustment (TN 183.5)

- Press the **V/M** button, then transmit and adjust the deviation for 0.5 kHz ( $\pm 0.1$  kHz) by rotating the **DIAL**, then press the **V/M** button. Rotate the **DIAL** to select the next setting.

## CTCSS Tx Deviation Adjustment (TN 254.1)

- Press the **V/M** button, then transmit and adjust the deviation for 0.5 kHz ( $\pm 0.1$  kHz) by rotating the **DIAL**, then press the **V/M** button. Rotate the **DIAL** to select the next setting.

## DCS Tx Deviation Adjustment (DCS DEV)

- Press the **V/M** button, then transmit and adjust the deviation for 0.6 kHz ( $\pm 0.1$  kHz) by rotating the **DIAL**, then press the **V/M** button. Rotate the **DIAL** to select the next setting.

Press the **MON/F** to activate the TX Power and Deviation alignment routine.

The alignment frequency will automatically be set to 146.000 MHz (USA Version: 148.000 MHz).

## High TX Power Adjustment (HI POWER)

- Transmit, and adjust the output power level for 5.0 W ( $\pm 0.3$  W) by rotating the **DIAL**, then press the **V/M** button. Rotate the **DIAL** to select the next setting.

## High TX Power Adjustment (L3 POWER)

- Transmit, and adjust the output power level for 2.5 W ( $\pm 0.2$  W) by rotating the **DIAL**, then press the **V/M** button. Rotate the **DIAL** to select the next setting.

## High TX Power Adjustment (L2 POWER)

- Transmit, and adjust the output power level for 1.0 W ( $\pm 0.1$  W) by rotating the **DIAL**, then press the **V/M** button. Rotate the **DIAL** to select the next setting.

## High TX Power Adjustment (L1 POWER)

- Transmit, and adjust the output power level for 50 mW (+50/-30 mW) by rotating the **DIAL**, then press the **V/M** button. Rotate the **DIAL** to select the next setting.

## TX Deviation Adjustment (MAX DEV)

- Inject a 1 kHz audio tone at a level of 50mV (rms) to the MIC jack. Press the **V/M** button, then transmit and adjust the deviation for 4.5 kHz ( $\pm 0.2$  kHz) (USA Version: 4.2 kHz ( $\pm 0.2$  kHz)) by rotating the **DIAL**, then press the **V/M** button. Rotate the **DIAL** to select the next setting.

## CTCSS Tx Deviation Adjustment (TN 67.0)

- Press the **V/M** button, then transmit and adjust the deviation for 0.5 kHz (+0.05/-0.1 kHz) by rotating the **DIAL**, then press the **V/M** button. Rotate the **DIAL** to select the next setting.

## CTCSS Tx Deviation Adjustment (TN 183.5)

- Press the **V/M** button, then transmit and adjust the deviation for 0.5 kHz ( $\pm 0.1$  kHz) by rotating the **DIAL**, then press the **V/M** button. Rotate the **DIAL** to select the next setting.

## CTCSS Tx Deviation Adjustment (TN 254.1)

- Press the **V/M** button, then transmit and adjust the deviation for 0.5 kHz ( $\pm 0.1$  kHz) by rotating the **DIAL**, then press the **V/M** button. Rotate the **DIAL** to select the next setting.

## *DCS Tx Deviation Adjustment (DCS DEV)*

- Press the **V/M** button, then transmit and adjust the deviation for 0.6 kHz ( $\pm 0.1$  kHz) by rotating the **DIAL**, then press the **V/M** button. Rotate the **DIAL** to select the next setting.

*NOTE: The next step depends on the geographical "version" of the transceiver being aligned:*

EXP Version: Alignment of the "SUB Band " follows (see page 18.)

USA Version: Press the BAND button to activate the 222 MHz band internal alignment routine. In this case, the alignment frequency will automatically be set to 222.000 MHz.

## **222 MHz Band Alignment**

### *L2 Tx Power Adjustment (L2 POWER)*

- Transmit, and adjust the output power level for 0.3 W ( $\pm 0.1$  W) by rotating the **DIAL**, then press the **V/M** button. Rotate the **DIAL** to select the next setting.

### *L1 Tx Power Adjustment (L1 POWER)*

- Transmit, and adjust the output power level for 50 mW (+50/-30 mW) by rotating the **DIAL**, then press the **V/M** button. Rotate the **DIAL** to select the next setting.

### *TX Deviation Adjustment (MAX DEV)*

- Inject a 1 kHz audio tone at a level of 50mV (rms) to the MIC jack. Press the **V/M** button, then transmit and adjust the deviation for 4.2 kHz ( $\pm 0.2$  kHz) by rotating the **DIAL**, then press the **V/M** button. Rotate the **DIAL** to select the next setting.

### *CTCSS Tx Deviation Adjustment (TN 67.0)*

- Press the **V/M** button, then transmit and adjust the deviation for 0.5 kHz (+0.05/-0.1 kHz) by rotating the **DIAL**, then press the **V/M** button. Rotate the **DIAL** to select the next setting.

### *CTCSS Tx Deviation Adjustment (TN 183.5)*

- Press the **V/M** button, then transmit and adjust the deviation for 0.5 kHz ( $\pm 0.1$  kHz) by rotating the **DIAL**, then press the **V/M** button. Rotate the **DIAL** to select the next setting.

### *CTCSS Tx Deviation Adjustment (TN 254.1)*

- Press the **V/M** button, then transmit and adjust the deviation for 0.5 kHz ( $\pm 0.1$  kHz) by rotating the **DIAL**, then press the **V/M** button. Rotate the **DIAL** to select the next setting.

## *DCS Tx Deviation Adjustment (DCS DEV)*

- Press the **V/M** button, then transmit and adjust the deviation for 0.6 kHz ( $\pm 0.1$  kHz) by rotating **DIAL**, then press the **V/M** button. Rotate the **DIAL** to select the next setting.

Press the **MON/F** to activate the TX Power and Deviation alignment routine.

The alignment frequency will automatically be set to 224.995 MHz.

### *High Tx Power Adjustment (L2 POWER)*

- Transmit, and adjust the output power level for 0.3 W ( $\pm 0.1$  W) by rotating the **DIAL**, then press the **V/M** button. Rotate the **DIAL** to select the next setting.

### *High Tx Power Adjustment (L1 POWER)*

- Transmit, and adjust the output power level for 50 mW (+50/-30 mW) by rotating the **DIAL**, then press the **V/M** button. Rotate the **DIAL** to select the next setting.

### *TX Deviation Adjustment (MAX DEV)*

- Inject a 1 kHz audio tone at a level of 50mV (rms) to the MIC jack. Press the **V/M** button, then transmit and adjust the deviation for 4.2 kHz  $\pm 0.2$  kHz by rotating **DIAL**, then press the **V/M** button. Rotate the **DIAL** to select the next setting.

### *CTCSS Tx Deviation Adjustment (TN 67.0)*

- Press the **V/M** button, then transmit and adjust the deviation for 0.5 kHz (+0.05/-0.1 kHz) by rotating the **DIAL**, then press the **V/M** button. Rotate the **DIAL** to select the next setting.

### *CTCSS Tx Deviation Adjustment (TN 183.5)*

- Press the **V/M** button, then transmit and adjust the deviation for 0.5 kHz ( $\pm 0.1$  kHz) by rotating the **DIAL**, then press the **V/M** button. Rotate the **DIAL** to select the next setting.

### *CTCSS Tx Deviation Adjustment (TN 254.1)*

- Press the **V/M** button, then transmit and adjust the deviation for 0.5 kHz ( $\pm 0.1$  kHz) by rotating the **DIAL**, then press the **V/M** button. Rotate the **DIAL** to select the next setting.

## *DCS Tx Deviation Adjustment (DCS DEV)*

- Press the **V/M** button, then transmit and adjust the deviation for 0.6 kHz ( $\pm 0.1$  kHz) by rotating the **DIAL**, then press the **V/M** button. Rotate the **DIAL** to select the next setting.

# Alignment

Press the **SUB** button to activate the SUB band internal alignment routine.

The alignment frequency will automatically be set to 435.100 MHz (USA Version: 440.100 MHz) on the SUB band.

## **SUB Band Alignment**

### **430 MHz Band Alignment**

*Squelch Hysteresis Adjustment* (HIS SQL)

- Rotate the **DIAL** for minimum squelch hysteresis. Press the **V/M** button, then rotate the **DIAL** to select the next setting.

*Squelch Preset Threshold* (THLD SQL)

- Inject a  $-13.0$  dB $\mu$  RF signal (1 kHz tone @  $\pm 3.5$  kHz deviation), then press the **V/M** button, then press the **MON/F** button twice. Press the **V/M** button, then rotate the **DIAL** to select the next setting.

*Squelch Preset Tight* (TIGH SQL)

- Adjust the generator level to  $-4.0$  dB $\mu$ , then press the **V/M** button, then press the **MON/F** button twice. Press the **V/M** button, then rotate the **DIAL** to select the next setting.

*S-Meter S-1 Adjustment* (S1 LEVEL)

- Adjust the generator level to  $-7.0$  dB $\mu$  (1 kHz tone @  $\pm 3.5$  kHz deviation), then press the **V/M** button, then press the **MON/F** button twice. Press the **V/M** button, then rotate the **DIAL** to select the next setting.

*S-Meter Full-Scale Adjustment* (S9 LEVEL)

- Adjust the generator level to  $+20$  dB $\mu$  (1 kHz tone @  $\pm 3.5$  kHz deviation), then press the **V/M** button, then press the **MON/F** button twice. Press the **V/M** button.

Press the **BAND** button to activate the 50 MHz SUB band internal alignment routine.

The alignment frequency will automatically be set to 52.100 MHz.

### **50 MHz SUB Band Alignment**

*Squelch Hysteresis Adjustment* (HIS SQL)

- Rotate the **DIAL** for minimum squelch hysteresis. Press the **V/M** button, then rotate the **DIAL** to select the next setting.

*Squelch Preset Threshold* (THLD SQL)

- Inject a  $-13.0$  dB $\mu$  RF signal (1 kHz tone @  $\pm 3.5$  kHz deviation), then press the **V/M** button, then press the **MON/F** button twice. Press the **V/M** button, then rotate the **DIAL** to select the next setting.

*Squelch Preset Tight* (TIGH SQL)

- Adjust the generator level to  $-4.0$  dB $\mu$ , then press the **V/M** button, then press the **MON/F** button twice. Press the **V/M** button, then rotate the **DIAL** to select the next setting.

*S-Meter S-1 Adjustment* (S1 LEVEL)

- Adjust the generator level to  $-7.0$  dB $\mu$  (1 kHz tone @  $\pm 3.5$  kHz deviation), then press the **V/M** button, then press the **MON/F** button twice. Press the **V/M** button, then rotate the **DIAL** to select the next setting.

*S-Meter Full-Scale Adjustment* (S9 LEVEL)

- Adjust the generator level to  $+19$  dB $\mu$  (1 kHz tone @  $\pm 3.5$  kHz deviation), then press the **V/M** button, then press the **MON/F** button twice. Press the **V/M** button.

Press the **BAND** button to activate the 144 MHz SUB band internal alignment routine.

The alignment frequency will automatically be set to 145.100 MHz (USA Version: 146.100 MHz).

### **144 MHz SUB Band Alignment**

*Squelch Hysteresis Adjustment* (HIS SQL)

- Rotate the **DIAL** for minimum squelch hysteresis. Press the **V/M** button, then rotate the **DIAL** to select the next setting.

*Squelch Preset Threshold* (THLD SQL)

- Inject a  $-15.0$  dB $\mu$  RF signal (1 kHz tone @  $\pm 3.5$  kHz deviation), then press the **V/M** button, then press the **MON/F** button twice. Press the **V/M** button, then rotate the **DIAL** to select the next setting.

*Squelch Preset Tight* (TIGH SQL)

- Adjust the generator level to  $-4.0$  dB $\mu$ , then press the **V/M** button, then press the **MON/F** button twice. Press the **V/M** button, then rotate the **DIAL** to select the next setting.

*S-Meter S-1 Adjustment* (S1 LEVEL)

- Adjust the generator level to  $-7.0$  dB $\mu$  (1 kHz tone @  $\pm 3.5$  kHz deviation), then press the **V/M** button, then press the **MON/F** button twice. Press the **V/M** button, then rotate the **DIAL** to select the next setting.

*S-Meter Full-Scale Adjustment* (S9 LEVEL)

- Adjust the generator level to  $+19$  dB $\mu$  (1 kHz tone @  $\pm 3.5$  kHz deviation), then press the **V/M** button, then presses the **MON/F** button twice. Press the **V/M** button.

This completes the internal alignment routine for all bands. To save all settings and exit, press the **HM/RV** button.



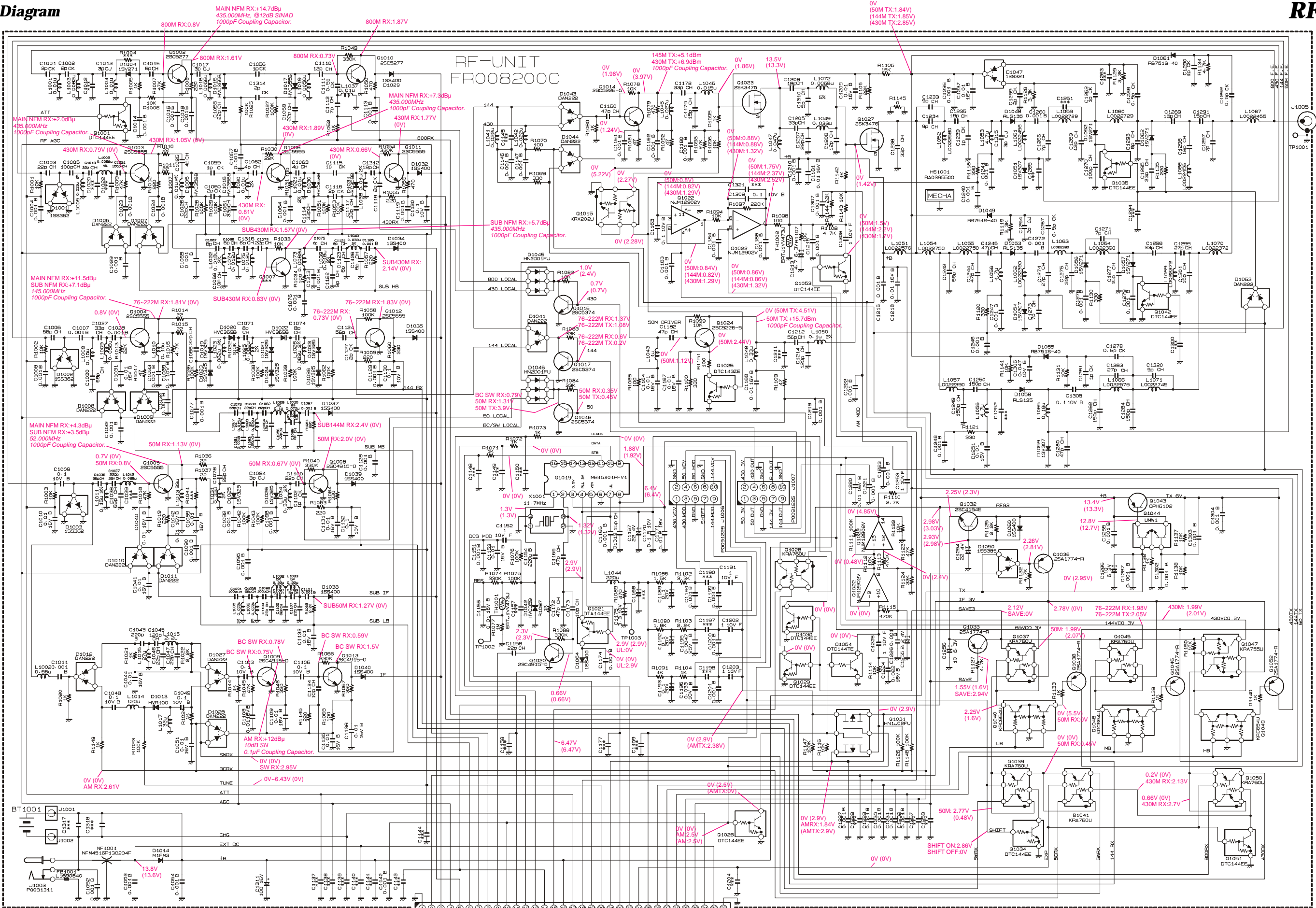

NOTE:  
 RESISTOR VALUES ARE IN Ω, K, M, 1/16W;  
 CAPACITOR VALUES ARE IN P, N, μF;  
 ELECTROLYTIC CAPACITORS ARE IN μF, 50V;  
 INDUCTOR VALUES ARE IN H, L, 10V;  
 UNLESS OTHERWISE NOTED.

EXTDCIN:13.5V  
 \*\*RX, (\*\*\*)TX

## Parts Layout

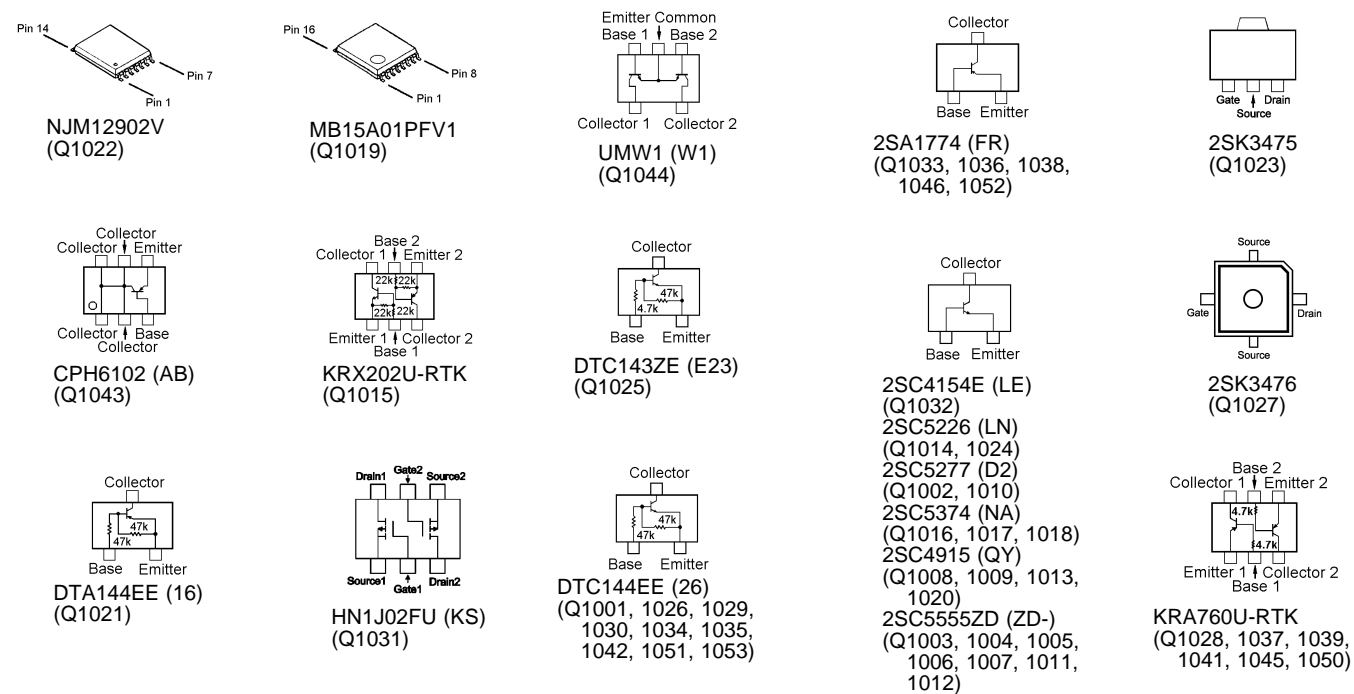
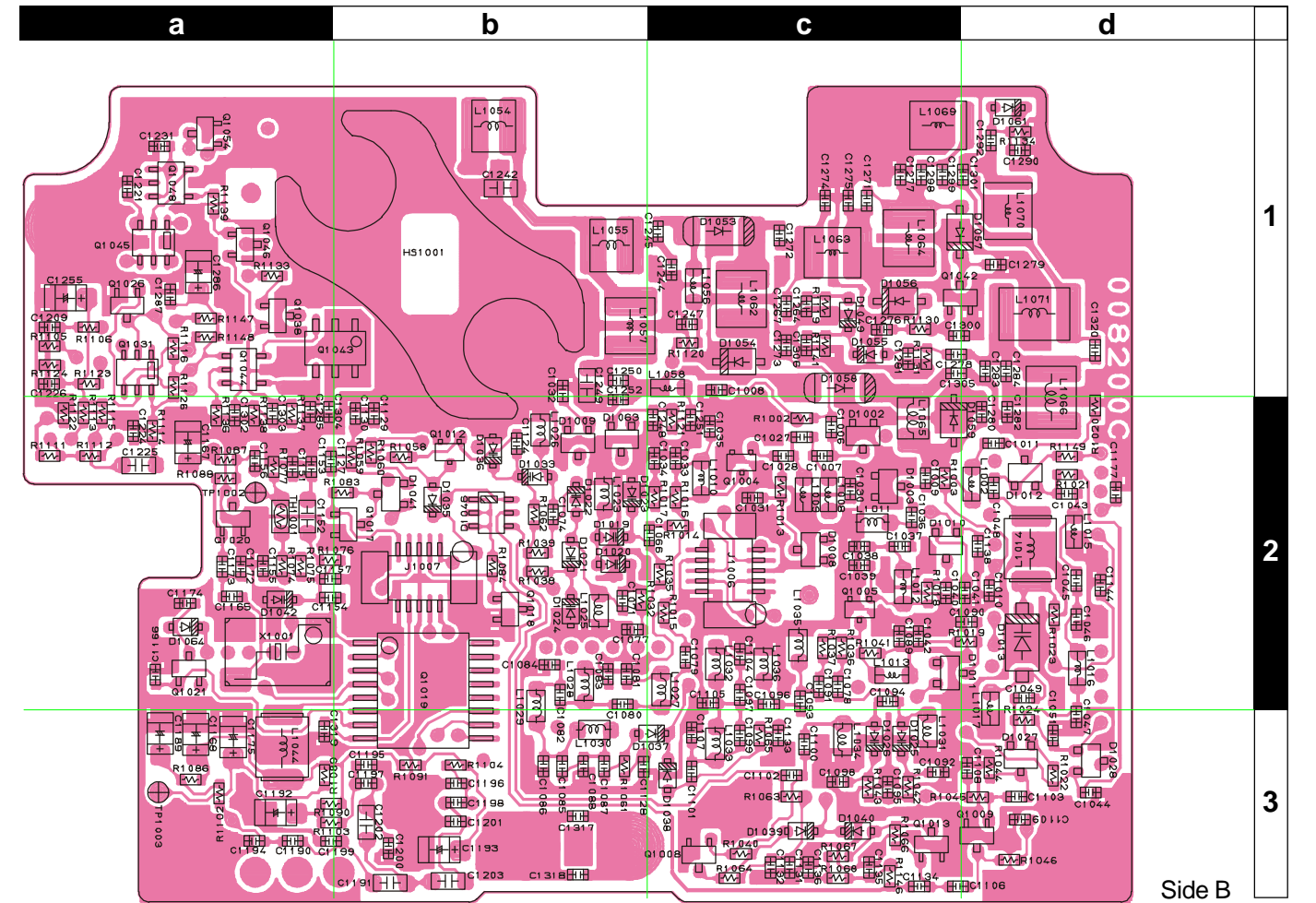
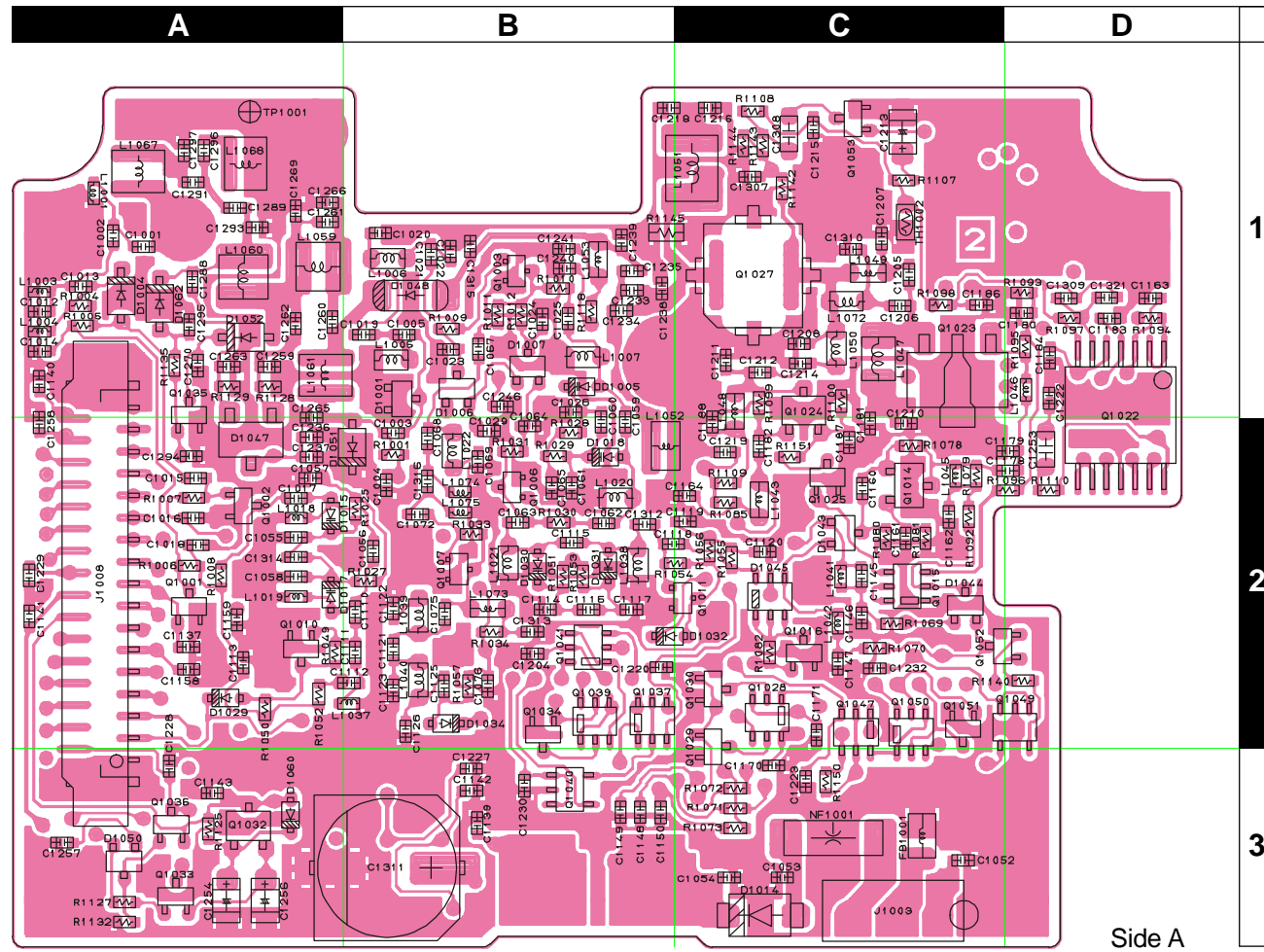



## Parts List

REF.	DESCRIPTION	VALUE	V/W	TOL.	MFR'S DESIG	VXSTD P/N	VERS.	LOT.	SIDE	LAY ADR.
PCB with Components (with VCO Unit)							USA	CB7372002		
PCB with Components (with VCO Unit)							EXPORT	CB7372003		
PCB with Components (with VCO Unit)							GERMANY	CB7372004		
Printed Circuit Board						FR008200C		1-		
C 1001	CHIP CAP.	2pF	50V	CK	UMK105CK020CW-F	K22178250		1-	A	A1
C 1002	CHIP CAP.	2pF	50V	CK	UMK105CK020CW-F	K22178250		1-	A	A1
C 1003	CHIP CAP.	22pF	50V	CH	UMK105CH220JW-F	K22178266		1-	A	B2
C 1004	CHIP CAP.	0.001uF	50V	B	UMK105B102KW-F	K22178829		1-	A	B2
C 1005	CHIP CAP.	100pF	50V	CH	UMK105CH101JW-F	K22178282		1-	A	B1
C 1006	CHIP CAP.	56pF	50V	CH	UMK105CH560JW-F	K22178276		1-	B	c2
C 1007	CHIP CAP.	0.001uF	50V	B	UMK105B102KW-F	K22178829		1-	B	c2
C 1008	CHIP CAP.	0.001uF	50V	B	UMK105B102KW-F	K22178829		1-	B	c1
C 1009	CHIP CAP.	0.1uF	10V	B	GRM36B104K10PT	K22108802		1-	B	c2
C 1010	CHIP CAP.	0.01uF	16V	B	GRM36B103K16PT	K22128804		1-	B	d2
C 1011	CHIP CAP.	0.1uF	10V	B	GRM36B104K10PT	K22108802		1-	B	d2
C 1013	CHIP CAP.	3pF	50V	CJ	UMK105CJ030CW-F	K22178251		1-	A	A1
C 1014	CHIP CAP.	0.001uF	50V	B	UMK105B102KW-F	K22178829		1-	A	A1
C 1015	CHIP CAP.	6pF	50V	CH	UMK105CH060DW-F	K22178254		1-	A	A2
C 1016	CHIP CAP.	0.001uF	50V	B	UMK105B102KW-F	K22178829		1-	A	A2
C 1017	CHIP CAP.	3pF	50V	CJ	UMK105CJ030CW-F	K22178251		1-	A	A2
C 1018	CHIP CAP.	0.001uF	50V	B	UMK105B102KW-F	K22178829		1-	A	A2
C 1019	CHIP CAP.	33pF	50V	CH	UMK105CH330JW-F	K22178270		1-	A	B1
C 1021	CHIP CAP.	100pF	50V	CH	UMK105CH101JW-F	K22178282		1-	A	B1
C 1023	CHIP CAP.	0.001uF	50V	B	UMK105B102KW-F	K22178829		1-	A	B1
C 1024	CHIP CAP.	0.001uF	50V	B	UMK105B102KW-F	K22178829		1-	A	B1
C 1025	CHIP CAP.	4pF	50V	CH	UMK105CH040CW-F	K22178252		1-	A	B1
C 1026	CHIP CAP.	22pF	50V	CH	UMK105CH220JW-F	K22178266		1-	A	B1
C 1027	CHIP CAP.	33pF	50V	CH	UMK105CH330JW-F	K22178270		1-	B	c2
C 1028	CHIP CAP.	0.001uF	50V	B	UMK105B102KW-F	K22178829		1-	B	c2
C 1029	CHIP CAP.	0.001uF	50V	B	UMK105B102KW-F	K22178829		1-	A	B2
C 1030	CHIP CAP.	68pF	50V	CH	UMK105CH680JW-F	K22178278		1-	B	c2
C 1031	CHIP CAP.	0.01uF	16V	B	GRM36B103K16PT	K22128804		1-	B	c2
C 1032	CHIP CAP.	0.001uF	50V	B	UMK105B102KW-F	K22178829		1-	B	b1
C 1033	CHIP CAP.	0.001uF	50V	B	UMK105B102KW-F	K22178829		1-	B	c2
C 1034	CHIP CAP.	0.001uF	50V	B	UMK105B102KW-F	K22178829		1-	B	c2
C 1035	CHIP CAP.	0.1uF	10V	B	GRM36B104K10PT	K22108802		1-	B	c2
C 1036	CHIP CAP.	56pF	50V	CH	UMK105CH560JW-F	K22178276		1-	B	c2
C 1037	CHIP CAP.	220pF	25V	CH	GRM36CH221J25PT	K22148203		1-	B	c2
C 1038	CHIP CAP.	68pF	50V	CH	UMK105CH680JW-F	K22178278		1-	B	c2
C 1040	CHIP CAP.	0.01uF	16V	B	GRM36B103K16PT	K22128804		1-	B	c2
C 1041	CHIP CAP.	0.01uF	16V	B	GRM36B103K16PT	K22128804		1-	B	d2
C 1042	CHIP CAP.	0.01uF	16V	B	GRM36B103K16PT	K22128804		1-	B	c2
C 1043	CHIP CAP.	0.001uF	50V	B	UMK105B102KW-F	K22178829		1-	B	d2
C 1044	CHIP CAP.	0.01uF	16V	B	GRM36B103K16PT	K22128804		1-	B	d3
C 1045	CHIP CAP.	0.001uF	50V	B	UMK105B102KW-F	K22178829		1-	B	d2
C 1046	CHIP CAP.	22pF	50V	CH	UMK105CH220JW-F	K22178266		1-	B	d2
C 1047	CHIP CAP.	22pF	50V	CH	UMK105CH220JW-F	K22178266		1-	B	d3
C 1048	CHIP CAP.	0.1uF	10V	B	GRM36B104K10PT	K22108802		1-	B	d2
C 1049	CHIP CAP.	0.1uF	10V	B	GRM36B104K10PT	K22108802		1-	B	d2
C 1051	CHIP CAP.	0.01uF	16V	B	GRM36B103K16PT	K22128804		1-	B	d3
C 1052	CHIP CAP.	0.001uF	50V	B	UMK105B102KW-F	K22178829		1-	A	C3
C 1053	CHIP CAP.	0.001uF	50V	B	UMK105B102KW-F	K22178829		1-	A	C3
C 1054	CHIP CAP.	0.001uF	50V	B	UMK105B102KW-F	K22178829		1-	A	C3
C 1055	CHIP CAP.	22pF	50V	CH	UMK105CH220JW-F	K22178266		1-	A	A2
C 1056	CHIP CAP.	1pF	50V	CK	UMK105CK010CW-F	K22178248		1-	A	B2
C 1057	CHIP CAP.	0.001uF	50V	B	UMK105B102KW-F	K22178829		1-	A	A2
C 1058	CHIP CAP.	22pF	50V	CH	UMK105CH220JW-F	K22178266		1-	A	A2
C 1059	CHIP CAP.	1pF	50V	CK	UMK105CK010CW-F	K22178248		1-	A	B2
C 1060	CHIP CAP.	2pF	50V	CK	UMK105CK020CW-F	K22178250		1-	A	B2
C 1061	CHIP CAP.	33pF	50V	CH	UMK105CH330JW-F	K22178270		1-	A	B2

# RF Unit

REF.	DESCRIPTION	VALUE	V/W	TOL.	MFR'S DESIG	VXSTD P/N	VERS.	LOT.	SIDE	LAY ADR.
C 1062	CHIP CAP.	4pF	50V	CH	UMK105CH040CW-F	K22178252		1-	A	B2
C 1063	CHIP CAP.	4pF	50V	CH	UMK105CH040CW-F	K22178252		1-	A	B2
C 1064	CHIP CAP.	0.001uF	50V	B	UMK105B102KW-F	K22178829		1-	A	B2
C 1065	CHIP CAP.	0.001uF	50V	B	UMK105B102KW-F	K22178829		1-	A	B2
C 1066	CHIP CAP.	22pF	50V	CH	UMK105CH220JW-F	K22178266		1-	B	b2
C 1067	CHIP CAP.	8pF	50V	CH	UMK105CH080DW-F	K22178256		1-	A	B1
C 1068	CHIP CAP.	6pF	50V	CH	UMK105CH060DW-F	K22178254		1-	A	B2
C 1069	CHIP CAP.	10pF	50V	CH	UMK105CH100DW-F	K22178258		1-	A	B2
C 1071	CHIP CAP.	8pF	50V	CH	UMK105CH080DW-F	K22178256		1-	B	b2
C 1072	CHIP CAP.	22pF	50V	CH	UMK105CH220JW-F	K22178266		1-	A	B2
C 1074	CHIP CAP.	8pF	50V	CH	UMK105CH080DW-F	K22178256		1-	B	b2
C 1075	CHIP CAP.	8pF	50V	CH	UMK105CH080DW-F	K22178256		1-	A	B2
C 1076	CHIP CAP.	0.001uF	50V	B	UMK105B102KW-F	K22178829		1-	A	B2
C 1077	CHIP CAP.	0.001uF	50V	B	UMK105B102KW-F	K22178829		1-	B	b2
C 1078	CHIP CAP.	22pF	50V	CH	UMK105CH220JW-F	K22178266		1-	B	c2
C 1079	CHIP CAP.	68pF	50V	CH	UMK105CH680JW-F	K22178278		1-	B	c2
C 1080	CHIP CAP.	22pF	50V	CH	UMK105CH220JW-F	K22178266		1-	B	b2
C 1081	CHIP CAP.	0.001uF	50V	B	UMK105B102KW-F	K22178829		1-	B	b2
C 1082	CHIP CAP.	82pF	50V	CH	UMK105CH820JW-F	K22178280		1-	B	b2
C 1083	CHIP CAP.	120pF	50V	CH	UMK105CH121JW-F	K22178284		1-	B	b2
C 1084	CHIP CAP.	12pF	50V	CH	UMK105CH120JW-F	K22178260		1-	B	b2
C 1085	CHIP CAP.	3pF	50V	CJ	UMK105CJ030CW-F	K22178251		1-	B	b3
C 1086	CHIP CAP.	22pF	50V	CH	UMK105CH220JW-F	K22178266		1-	B	b3
C 1087	CHIP CAP.	0.001uF	50V	B	UMK105B102KW-F	K22178829		1-	B	b3
C 1088	CHIP CAP.	8pF	50V	CH	UMK105CH080DW-F	K22178256		1-	B	b3
C 1089	CHIP CAP.	0.01uF	16V	B	GRM36B103K16PT	K22128804		1-	B	c2
C 1090	CHIP CAP.	0.001uF	50V	B	UMK105B102KW-F	K22178829		1-	B	d2
C 1091	CHIP CAP.	100pF	50V	CH	UMK105CH101JW-F	K22178282		1-	B	c2
C 1092	CHIP CAP.	0.001uF	50V	B	UMK105B102KW-F	K22178829		1-	B	c3
C 1093	CHIP CAP.	68pF	50V	CH	UMK105CH680JW-F	K22178278		1-	B	c2
C 1094	CHIP CAP.	3pF	50V	CJ	UMK105CJ030CW-F	K22178251		1-	B	c2
C 1095	CHIP CAP.	0.001uF	50V	B	UMK105B102KW-F	K22178829		1-	B	c3
C 1096	CHIP CAP.	100pF	50V	CH	UMK105CH101JW-F	K22178282		1-	B	c2
C 1097	CHIP CAP.	5pF	50V	CH	UMK105CH050CW-F	K22178253		1-	B	c2
C 1098	CHIP CAP.	0.001uF	50V	B	UMK105B102KW-F	K22178829		1-	B	c3
C 1099	CHIP CAP.	5pF	50V	CH	UMK105CH050CW-F	K22178253		1-	B	c3
C 1100	CHIP CAP.	22pF	50V	CH	UMK105CH220JW-F	K22178266		1-	B	c3
C 1101	CHIP CAP.	0.001uF	50V	B	UMK105B102KW-F	K22178829		1-	B	c3
C 1102	CHIP CAP.	1pF	50V	CK	UMK105CK010CW-F	K22178248		1-	B	c3
C 1103	CHIP CAP.	0.1uF	10V	B	GRM36B104K10PT	K22108802		1-	B	d3
C 1104	CHIP CAP.	27pF	50V	CH	UMK105CH270JW-F	K22178268		1-	B	c2
C 1105	CHIP CAP.	82pF	50V	CH	UMK105CH820JW-F	K22178280		1-	B	c2
C 1106	CHIP CAP.	0.1uF	10V	B	GRM36B104K10PT	K22108802		1-	B	c3
C 1107	CHIP CAP.	27pF	50V	CH	UMK105CH270JW-F	K22178268		1-	B	c3
C 1108	CHIP CAP.	0.01uF	16V	B	GRM36B103K16PT	K22128804		1-	B	d3
C 1109	CHIP CAP.	0.01uF	16V	B	GRM36B103K16PT	K22128804		1-	B	d3
C 1110	CHIP CAP.	12pF	50V	CH	UMK105CH120JW-F	K22178260		1-	A	B2
C 1111	CHIP CAP.	0.5pF	50V	CK	UMK105CK0R5CW-F	K22178247		1-	A	B2
C 1112	CHIP CAP.	7pF	50V	CH	UMK105CH070DW-F	K22178255		1-	A	B2
C 1113	CHIP CAP.	0.001uF	50V	B	UMK105B102KW-F	K22178829		1-	A	A2
C 1114	CHIP CAP.	33pF	50V	CH	UMK105CH330JW-F	K22178270		1-	A	B2
C 1115	CHIP CAP.	1pF	50V	CK	UMK105CK010CW-F	K22178248		1-	A	B2
C 1116	CHIP CAP.	2pF	50V	CK	UMK105CK020CW-F	K22178250		1-	A	B2
C 1117	CHIP CAP.	33pF	50V	CH	UMK105CH330JW-F	K22178270		1-	A	B2
C 1118	CHIP CAP.	2pF	50V	CK	UMK105CK020CW-F	K22178250		1-	A	B2
C 1119	CHIP CAP.	0.001uF	50V	B	UMK105B102KW-F	K22178829		1-	A	C2
C 1120	CHIP CAP.	0.1uF	10V	B	GRM36B104K10PT	K22108802		1-	A	C2
C 1121	CHIP CAP.	8pF	50V	CH	UMK105CH080DW-F	K22178256		1-	A	B2
C 1122	CHIP CAP.	9pF	50V	CH	UMK105CH090DW-F	K22178257		1-	A	B2
C 1123	CHIP CAP.	6pF	50V	CH	UMK105CH060DW-F	K22178254		1-	A	B2

REF.	DESCRIPTION	VALUE	V/W	TOL.	MFR'S DESIG	VXSTD P/N	VERS.	LOT.	SIDE	LAY ADR.
C 1124	CHIP CAP.	56pF	50V	CH	UMK105CH560JW-F	K22178276		1-	B	b2
C 1125	CHIP CAP.	0.001uF	50V	B	UMK105B102KW-F	K22178829		1-	A	B2
C 1126	CHIP CAP.	6pF	50V	CH	UMK105CH060DW-F	K22178254		1-	A	B2
C 1127	CHIP CAP.	2pF	50V	CK	UMK105CK020CW-F	K22178250		1-	B	a2
C 1128	CHIP CAP.	0.001uF	50V	B	UMK105B102KW-F	K22178829		1-	B	b3
C 1129	CHIP CAP.	0.001uF	50V	B	UMK105B102KW-F	K22178829		1-	B	b2
C 1130	CHIP CAP.	0.1uF	10V	B	GRM36B104K10PT	K22108802		1-	B	b2
C 1131	CHIP CAP.	0.01uF	16V	B	GRM36B103K16PT	K22128804		1-	B	c3
C 1132	CHIP CAP.	0.1uF	10V	B	GRM36B104K10PT	K22108802		1-	B	c3
C 1133	CHIP CAP.	0.01uF	16V	B	GRM36B103K16PT	K22128804		1-	B	c3
C 1134	CHIP CAP.	10pF	50V	CH	UMK105CH100DW-F	K22178258		1-	B	c3
C 1135	CHIP CAP.	0.01uF	16V	B	GRM36B103K16PT	K22128804		1-	B	c3
C 1136	CHIP CAP.	0.01uF	16V	B	GRM36B103K16PT	K22128804		1-	B	c3
C 1139	CHIP CAP.	0.001uF	50V	B	UMK105B102KW-F	K22178829		1-	A	B3
C 1142	CHIP CAP.	0.001uF	50V	B	UMK105B102KW-F	K22178829		1-	A	B3
C 1143	CHIP CAP.	0.001uF	50V	B	UMK105B102KW-F	K22178829		1-	A	A3
C 1145	CHIP CAP.	22pF	50V	CH	UMK105CH220JW-F	K22178266		1-	A	C2
C 1146	CHIP CAP.	0.001uF	50V	B	UMK105B102KW-F	K22178829		1-	A	C2
C 1147	CHIP CAP.	0.001uF	50V	B	UMK105B102KW-F	K22178829		1-	A	C2
C 1151	CHIP CAP.	0.001uF	50V	B	UMK105B102KW-F	K22178829		1-	B	a2
C 1152	CHIP CAP.	1uF	10V	F	GRM39F105Z10PT	K22105001		1-	B	a2
C 1153	CHIP CAP.	0.01uF	16V	B	GRM36B103K16PT	K22128804		1-	B	a2
C 1154	CHIP CAP.	220pF	50V	B	UMK105B221KW-F	K22178821		1-	B	a2
C 1155	CHIP CAP.	0.01uF	16V	B	GRM36B103K16PT	K22128804		1-	B	a2
C 1156	CHIP CAP.	22pF	50V	CH	UMK105CH220JW-F	K22178266		1-	B	a2
C 1159	CHIP CAP.	0.001uF	50V	B	UMK105B102KW-F	K22178829		1-	A	A2
C 1160	CHIP CAP.	47pF	50V	CH	UMK105CH470JW-F	K22178274		1-	A	C2
C 1161	CHIP CAP.	0.001uF	50V	B	UMK105B102KW-F	K22178829		1-	A	C2
C 1162	CHIP CAP.	0.001uF	50V	B	UMK105B102KW-F	K22178829		1-	A	C2
C 1163	CHIP CAP.	0.1uF	10V	B	GRM36B104K10PT	K22108802		1-	A	D1
C 1164	CHIP CAP.	0.01uF	16V	B	GRM36B103K16PT	K22128804		1-	A	C2
C 1165	CHIP CAP.	47pF	50V	CH	UMK105CH470JW-F	K22178274		1-	B	a2
C 1166	CHIP CAP.	0.001uF	50V	B	UMK105B102KW-F	K22178829		1-	B	a2
C 1167	CHIP TA.CAP.	22uF	4V		TESVSP0G226M-8R	K78060047		1-	B	a2
C 1170	CHIP CAP.	0.1uF	10V	B	GRM36B104K10PT	K22108802		1-	A	C3
C 1171	CHIP CAP.	0.01uF	16V	B	GRM36B103K16PT	K22128804		1-	A	C2
C 1172	CHIP CAP.	47pF	50V	CH	UMK105CH470JW-F	K22178274		1-	B	a2
C 1173	CHIP CAP.	10pF	50V	CH	UMK105CH100DW-F	K22178258		1-	B	a2
C 1174	CHIP CAP.	0.001uF	50V	B	UMK105B102KW-F	K22178829		1-	B	a2
C 1175	CHIP TA.CAP.	1.5uF	10V		TESVSP1A155M-8R	K78100050		1-	B	a3
C 1178	CHIP CAP.	33pF	50V	CH	UMK105CH330JW-F	K22178270		1-	A	D2
C 1179	CHIP CAP.	15pF	50V	CH	UMK105CH150JW-F	K22178262		1-	A	D2
C 1180	CHIP CAP.	0.001uF	50V	B	UMK105B102KW-F	K22178829		1-	A	D1
C 1181	CHIP CAP.	0.01uF	16V	B	GRM36B103K16PT	K22128804		1-	A	C2
C 1182	CHIP CAP.	47pF	50V	CH	UMK105CH470JW-F	K22178274		1-	A	C2
C 1183	CHIP CAP.	0.001uF	50V	B	UMK105B102KW-F	K22178829		1-	A	D1
C 1184	CHIP CAP.	0.001uF	50V	B	UMK105B102KW-F	K22178829		1-	A	D1
C 1186	CHIP CAP.	0.001uF	50V	B	UMK105B102KW-F	K22178829		1-	A	C1
C 1187	CHIP CAP.	0.01uF	16V	B	GRM36B103K16PT	K22128804		1-	A	C2
C 1188	CHIP CAP.	0.01uF	16V	B	GRM36B103K16PT	K22128804		1-	A	C2
C 1189	CHIP TA.CAP.	0.1uF	20V		SKF-1D104M-RP	K78130049		1-	B	a3
C 1190	CHIP CAP.	12pF	50V	CH	UMK105CH120JW-F	K22178260	USA	1-	B	a3
C 1190	CHIP CAP.	12pF	50V	CH	UMK105CH120JW-F	K22178260	EXPORT	2-	B	a3
C 1191	CHIP CAP.	1uF	10V	F	GRM39F105Z10PT	K22105001		1-	B	b3
C 1192	CHIP TA.CAP.	0.1uF	20V		SKF-1D104M-RP	K78130049		1-	B	a3
C 1193	CHIP TA.CAP.	0.1uF	20V		SKF-1D104M-RP	K78130049		1-	B	b3
C 1194	CHIP CAP.	0.001uF	50V	B	UMK105B102KW-F	K22178829		1-	B	a3
C 1195	CHIP CAP.	0.01uF	16V	B	GRM36B103K16PT	K22128804		1-	B	b3
C 1196	CHIP CAP.	0.033uF	10V	B	GRM36B333K10PT	K22108803		1-	B	b3
C 1199	CHIP CAP.	0.001uF	50V	B	UMK105B102KW-F	K22178829		1-	B	a3

# RF Unit

REF.	DESCRIPTION	VALUE	V/W	TOL.	MFR'S DESIG	VXSTD P/N	VERS.	LOT.	SIDE	LAY ADR.
C 1200	CHIP CAP.	0.001uF	50V	B	UMK105B102KW-F	K22178829		1-	B	b3
C 1201	CHIP CAP.	0.001uF	50V	B	UMK105B102KW-F	K22178829		1-	B	b3
C 1202	CHIP CAP.	1uF	10V	F	GRM39F105Z10PT	K22105001		1-	B	b3
C 1203	CHIP CAP.	1uF	10V	F	GRM39F105Z10PT	K22105001		1-	B	b3
C 1205	CHIP CAP.	33pF	50V	CH	UMK105CH330JW-F	K22178270	GERMANY	1-	A	C1
C 1205	CHIP CAP.	27pF	50V	CH	UMK105CH270JW-F	K22178268	USA	1-	A	C1
C 1205	CHIP CAP.	33pF	50V	CH	UMK105CH330JW-F	K22178270	EXPORT	1-	A	C1
C 1205	CHIP CAP.	27pF	50V	CH	UMK105CH270JW-F	K22178268	EXPORT	2-	A	C1
C 1206	CHIP CAP.	18pF	50V	CH	UMK105CH180JW-F	K22178264		1-	A	C1
C 1207	CHIP CAP.	10pF	50V	CH	UMK105CH100DW-F	K22178258	USA	1-	A	C1
C 1207	CHIP CAP.	22pF	50V	CH	UMK105CH220JW-F	K22178266	EXPORT	1-	A	C1
C 1207	CHIP CAP.	10pF	50V	CH	UMK105CH100DW-F	K22178258	EXPORT	2-	A	C1
C 1207	CHIP CAP.	22pF	50V	CH	UMK105CH220JW-F	K22178266	GERMANY	1-	A	C1
C 1208	CHIP CAP.	15pF	50V	CH	UMK105CH150JW-F	K22178262	EXPORT	1-	A	C1
C 1208	CHIP CAP.	15pF	50V	CH	UMK105CH150JW-F	K22178262	GERMANY	1-	A	C1
C 1209	CHIP CAP.	0.01uF	16V	B	GRM36B103K16PT	K22128804		1-	B	a1
C 1210	CHIP CAP.	0.001uF	50V	B	UMK105B102KW-F	K22178829		1-	A	C2
C 1212	CHIP CAP.	56pF	50V	CH	UMK105CH560JW-F	K22178276		1-	A	C1
C 1213	CHIP TA.CAP.	4.7uF	6.3V		TESVSP0J475M-8R	K78080053		1-	A	C1
C 1214	CHIP CAP.	120pF	50V	CH	UMK105CH121JW-F	K22178284		1-	A	C1
C 1215	CHIP CAP.	0.001uF	50V	B	UMK105B102KW-F	K22178829		1-	A	C1
C 1216	CHIP CAP.	0.001uF	50V	B	UMK105B102KW-F	K22178829		1-	A	C1
C 1218	CHIP CAP.	0.01uF	16V	B	GRM36B103K16PT	K22128804		1-	A	B1
C 1219	CHIP CAP.	0.001uF	50V	B	UMK105B102KW-F	K22178829		1-	A	C2
C 1220	CHIP CAP.	0.01uF	16V	B	GRM36B103K16PT	K22128804		1-	A	B2
C 1221	CHIP CAP.	0.001uF	50V	B	UMK105B102KW-F	K22178829		1-	B	a1
C 1222	CHIP CAP.	0.001uF	50V	B	UMK105B102KW-F	K22178829		1-	A	D1
C 1223	CHIP CAP.	0.001uF	50V	B	UMK105B102KW-F	K22178829		1-	A	C3
C 1224	CHIP CAP.	0.022uF	16V	B	GRM36B223K16PT	K22128806		1-	B	a2
C 1225	CHIP CAP.	1uF	10V	F	GRM39F105Z10PT	K22105001		1-	B	a2
C 1226	CHIP CAP.	0.001uF	50V	B	UMK105B102KW-F	K22178829		1-	B	a1
C 1227	CHIP CAP.	0.001uF	50V	B	UMK105B102KW-F	K22178829		1-	A	B3
C 1228	CHIP CAP.	0.001uF	50V	B	UMK105B102KW-F	K22178829		1-	A	A3
C 1229	CHIP CAP.	0.001uF	50V	B	UMK105B102KW-F	K22178829		1-	A	A2
C 1230	CHIP CAP.	0.001uF	50V	B	UMK105B102KW-F	K22178829		1-	A	B3
C 1231	CHIP CAP.	0.001uF	50V	B	UMK105B102KW-F	K22178829		1-	B	a1
C 1232	CHIP CAP.	0.001uF	50V	B	UMK105B102KW-F	K22178829		1-	A	C2
C 1233	CHIP CAP.	10pF	50V	CH	UMK105CH100DW-F	K22178258		1-	A	B1
C 1234	CHIP CAP.	12pF	50V	CH	UMK105CH120JW-F	K22178260		1-	A	B1
C 1235	CHIP CAP.	22pF	50V	CH	UMK105CH220JW-F	K22178266		1-	A	B1
C 1236	CHIP CAP.	0.001uF	50V	B	UMK105B102KW-F	K22178829		1-	A	A2
C 1237	CHIP CAP.	0.01uF	16V	B	GRM36B103K16PT	K22128804		1-	A	A2
C 1238	CHIP CAP.	33pF	50V	CH	UMK105CH330JW-F	K22178270		1-	A	B1
C 1239	CHIP CAP.	1pF	50V	CK	UMK105CK010CW-F	K22178248		1-	A	B1
C 1240	CHIP CAP.	0.001uF	50V	B	UMK105B102KW-F	K22178829		1-	A	B1
C 1241	CHIP CAP.	0.001uF	50V	B	UMK105B102KW-F	K22178829		1-	A	B1
C 1242	CHIP CAP.	68pF	50V	CH	GRM39CH680J50PT	K22174231		1-	B	b1
C 1244	CHIP CAP.	33pF	50V	CH	UMK105CH330JW-F	K22178270		1-	B	c1
C 1245	CHIP CAP.	39pF	50V	CH	UMK105CH390JW-F	K22178272		1-	B	c1
C 1246	CHIP CAP.	0.001uF	50V	B	UMK105B102KW-F	K22178829		1-	A	B1
C 1247	CHIP CAP.	0.001uF	50V	B	UMK105B102KW-F	K22178829		1-	B	c1
C 1248	CHIP CAP.	0.001uF	50V	B	UMK105B102KW-F	K22178829		1-	B	c2
C 1249	CHIP CAP.	150pF	50V	CH	GRM39CH151J50PT	K22174239		1-	B	b1
C 1250	CHIP CAP.	220pF	25V	CH	GRM36CH221J25PT	K22148203		1-	B	b1
C 1251	CHIP CAP.	0.01uF	16V	B	GRM36B103K16PT	K22128804		1-	B	c2
C 1253	CHIP CAP.	1uF	10V	F	GRM39F105Z10PT	K22105001		1-	A	D2
C 1254	CHIP TA.CAP.	22uF	4V		TESVSP0G226M-8R	K78060047		1-	A	A3
C 1255	CHIP TA.CAP.	2.2uF	4V		TESVSP0G225M-8R	K78060025		1-	B	a1
C 1256	CHIP TA.CAP.	10uF	6.3V		TESVSP0J106M-8R	K78080055		1-	A	A3
C 1257	CHIP CAP.	0.001uF	50V	B	UMK105B102KW-F	K22178829		1-	A	A3

REF.	DESCRIPTION	VALUE	V/W	TOL.	MFR'S DESIG	VXSTD P/N	VERS.	LOT.	SIDE	LAY ADR.
C 1258	CHIP CAP.	0.001uF	50V	B	UMK105B102KW-F	K22178829		1-	A	A2
C 1259	CHIP CAP.	2pF	50V	CK	UMK105CK020CW-F	K22178250		1-	A	A1
C 1260	CHIP CAP.	0.001uF	50V	B	UMK105B102KW-F	K22178829		1-	A	A1
C 1262	CHIP CAP.	1pF	50V	CK	UMK105CK010CW-F	K22178248		1-	A	A1
C 1264	CHIP CAP.	3pF	50V	CJ	UMK105CJ030CW-F	K22178251		1-	B	c1
C 1266	CHIP CAP.	7pF	50V	CH	UMK105CH070DW-F	K22178255		1-	A	A1
C 1267	CHIP CAP.	0.5pF	50V	CK	GRM36CK0R5B50PT	K22178285		1-	B	c1
C 1269	CHIP CAP.	12pF	50V	CH	UMK105CH120JW-F	K22178260		1-	A	A1
C 1270	CHIP CAP.	39pF	50V	CH	UMK105CH390JW-F	K22178272		1-	A	A1
C 1271	CHIP CAP.	7pF	50V	CH	UMK105CH070DW-F	K22178255		1-	B	c1
C 1272	CHIP CAP.	0.001uF	50V	B	UMK105B102KW-F	K22178829		1-	B	c1
C 1273	CHIP CAP.	7pF	50V	CH	UMK105CH070DW-F	K22178255		1-	B	c1
C 1274	CHIP CAP.	33pF	50V	CH	UMK105CH330JW-F	K22178270		1-	B	c1
C 1275	CHIP CAP.	22pF	50V	CH	UMK105CH220JW-F	K22178266		1-	B	c1
C 1276	CHIP CAP.	0.001uF	50V	B	UMK105B102KW-F	K22178829		1-	B	c1
C 1277	CHIP CAP.	15pF	50V	CH	UMK105CH150JW-F	K22178262		1-	B	c1
C 1278	CHIP CAP.	0.5pF	50V	CK	GRM36CK0R5B50PT	K22178285		1-	B	c1
C 1279	CHIP CAP.	0.001uF	50V	B	UMK105B102KW-F	K22178829		1-	B	d1
C 1280	CHIP CAP.	39pF	50V	CH	UMK105CH390JW-F	K22178272		1-	B	d2
C 1281	CHIP CAP.	1pF	50V	CK	UMK105CK010CW-F	K22178248		1-	B	c1
C 1282	CHIP CAP.	150pF	50V	CH	GRM36CH151J50PT	K22178240		1-	B	d2
C 1283	CHIP CAP.	27pF	50V	CH	UMK105CH270JW-F	K22178268		1-	B	d1
C 1284	CHIP CAP.	150pF	50V	CH	GRM36CH151J50PT	K22178240		1-	B	d1
C 1285	CHIP CAP.	0.001uF	50V	B	UMK105B102KW-F	K22178829		1-	B	a2
C 1286	CHIP TA.CAP.	10uF	6.3V		TESVSP0J106M-8R	K78080055		1-	B	a1
C 1287	CHIP CAP.	0.001uF	50V	B	UMK105B102KW-F	K22178829		1-	B	a1
C 1288	CHIP CAP.	0.5pF	50V	CK	GRM36CK0R5B50PT	K22178285		1-	A	A1
C 1289	CHIP CAP.	15pF	50V	CH	UMK105CH150JW-F	K22178262		1-	A	A1
C 1290	CHIP CAP.	1pF	50V	CK	UMK105CK010CW-F	K22178248		1-	B	d1
C 1291	CHIP CAP.	15pF	50V	CH	UMK105CH150JW-F	K22178262		1-	A	A1
C 1292	CHIP CAP.	0.5pF	50V	CK	GRM36CK0R5B50PT	K22178285		1-	B	d1
C 1293	CHIP CAP.	8pF	50V	CH	UMK105CH080DW-F	K22178256		1-	A	A1
C 1295	CHIP CAP.	47pF	50V	CH	UMK105CH470JW-F	K22178274		1-	A	A1
C 1296	CHIP CAP.	18pF	50V	CH	UMK105CH180JW-F	K22178264		1-	A	A1
C 1297	CHIP CAP.	7pF	50V	CH	UMK105CH070DW-F	K22178255		1-	A	A1
C 1298	CHIP CAP.	33pF	50V	CH	UMK105CH330JW-F	K22178270		1-	B	c1
C 1299	CHIP CAP.	27pF	50V	CH	UMK105CH270JW-F	K22178268		1-	B	c1
C 1301	CHIP CAP.	12pF	50V	CH	UMK105CH120JW-F	K22178260		1-	B	c1
C 1302	CHIP CAP.	0.001uF	50V	B	UMK105B102KW-F	K22178829		1-	B	a2
C 1303	CHIP CAP.	0.001uF	50V	B	UMK105B102KW-F	K22178829		1-	B	a2
C 1304	CHIP CAP.	0.001uF	50V	B	UMK105B102KW-F	K22178829		1-	B	a2
C 1305	CHIP CAP.	0.1uF	10V	B	GRM36B104K10PT	K22108802		1-	B	c1
C 1306	CHIP CAP.	0.047uF	10V	B	GRM36B473K10PT	K22108801		1-	B	c1
C 1307	CHIP CAP.	0.001uF	50V	B	UMK105B102KW-F	K22178829		1-	A	C1
C 1308	CHIP CAP.	1uF	10V	F	GRM39F105Z10PT	K22105001		1-	A	C1
C 1309	CHIP CAP.	0.1uF	10V	B	GRM36B104K10PT	K22108802		1-	A	D1
C 1310	CHIP CAP.	4pF	50V	CH	UMK105CH040CW-F	K22178252	USA	1-	A	C1
C 1310	CHIP CAP.	5pF	50V	CH	UMK105CH050CW-F	K22178253	EXPORT	1-	A	C1
C 1310	CHIP CAP.	4pF	50V	CH	UMK105CH040CW-F	K22178252	EXPORT	2-	A	C1
C 1310	CHIP CAP.	5pF	50V	CH	UMK105CH050CW-F	K22178253	GERMANY	1-	A	C1
C 1311	AL.ELECTRO.CAP.	100uF	16V		ECEV1CA101WP	K48120012		1-	A	B3
C 1312	CHIP CAP.	12pF	50V	CH	UMK105CH120JW-F	K22178260		1-	A	B2
C 1313	CHIP CAP.	0.001uF	50V	B	UMK105B102KW-F	K22178829		1-	A	B2
C 1314	CHIP CAP.	2pF	50V	CK	UMK105CK020CW-F	K22178250		1-	A	A2
C 1315	CHIP CAP.	3pF	50V	CJ	UMK105CJ030CW-F	K22178251		1-	A	B1
C 1316	CHIP CAP.	6pF	50V	CH	UMK105CH060DW-F	K22178254		1-	A	B2
C 1317	CHIP CAP.	0.001uF	50V	B	UMK105B102KW-F	K22178829		1-	B	b3
C 1319	CHIP CAP.	15pF	50V	CH	UMK105CH150JW-F	K22178262		1-	B	a3
C 1320	CHIP CAP.	12pF	50V	CH	UMK105CH120JW-F	K22178260		1-	B	d1
C 1322	CHIP CAP.	10pF	50V	CH	UMK105CH100DW-F	K22178258		1-		

# RF Unit

REF.	DESCRIPTION	VALUE	V/W	TOL.	MFR'S DESIG	VXSTD P/N	VERS.	LOT.	SIDE	LAY ADR.
C 1323	CHIP CAP.	0.001uF	50V	B	UMK105B102KW-F	K22178829		1-		
D 1001	DIODE				1SS362 TE85R	G2070268		1-	A	B1
D 1002	DIODE				1SS362 TE85R	G2070268		1-	B	c2
D 1003	DIODE				1SS362 TE85R	G2070268		1-	B	c2
D 1004	DIODE				1SV271 TPH3	G2070476		1-	A	A1
D 1005	DIODE				HVC358B(TAPE)	G2070590		1-	A	B1
D 1006	DIODE				DAN222 TL	G2070174		1-	A	B1
D 1007	DIODE				DAN222 TL	G2070174		1-	A	B1
D 1008	DIODE				DAN222 TL	G2070174		1-	B	c2
D 1009	DIODE				DAN222 TL	G2070174		1-	B	b2
D 1010	DIODE				DAN222 TL	G2070174		1-	B	c2
D 1011	DIODE				DAN222 TL	G2070174		1-	B	c2
D 1012	DIODE				DAN222 TL	G2070174		1-	B	d2
D 1013	DIODE				HVR100-8TRU	G2070540		1-	B	d2
D 1014	DIODE				M1FM3-4063	G2070804		1-	A	C3
D 1015	DIODE				HVC355B(TAPE)	G2070588		1-	A	A2
D 1017	DIODE				HVC355B(TAPE)	G2070588		1-	A	A2
D 1018	DIODE				HVC358B(TAPE)	G2070590		1-	A	B2
D 1019	DIODE				1SV325(TPH3)	G2070848		1-	B	b2
D 1020	DIODE				HVC369B TRF	G2070872		1-	B	b2
D 1021	DIODE				1SV325(TPH3)	G2070848		1-	B	b2
D 1022	DIODE				HVC369B TRF	G2070872		1-	B	b2
D 1023	DIODE				1SV325(TPH3)	G2070848		1-	B	b2
D 1024	DIODE				1SV325(TPH3)	G2070848		1-	B	b2
D 1025	DIODE				1SV325(TPH3)	G2070848		1-	B	c3
D 1026	DIODE				1SV325(TPH3)	G2070848		1-	B	c3
D 1027	DIODE				DAN222 TL	G2070174		1-	B	d3
D 1028	DIODE				DAN222 TL	G2070174		1-	B	d3
D 1029	DIODE				1SS400 TE61	G2070634		1-	A	A2
D 1030	DIODE				HVC358B(TAPE)	G2070590		1-	A	B2
D 1031	DIODE				HVC358B(TAPE)	G2070590		1-	A	B2
D 1032	DIODE				1SS400 TE61	G2070634		1-	A	B2
D 1033	DIODE				1SV325(TPH3)	G2070848		1-	B	b2
D 1034	DIODE				1SS400 TE61	G2070634		1-	A	B2
D 1035	DIODE				1SS400 TE61	G2070634		1-	B	b2
D 1036	DIODE				1SV325(TPH3)	G2070848		1-	B	b2
D 1037	DIODE				1SS400 TE61	G2070634		1-	B	c3
D 1038	DIODE				1SS400 TE61	G2070634		1-	B	c3
D 1039	DIODE				1SS400 TE61	G2070634		1-	B	c3
D 1040	DIODE				1SS400 TE61	G2070634		1-	B	c3
D 1041	DIODE				DAN222 TL	G2070174		1-	B	b2
D 1042	DIODE				HVC359 TRF	G2070708		1-	B	a2
D 1043	DIODE				DAN222 TL	G2070174		1-	A	C2
D 1044	DIODE				DAN222 TL	G2070174		1-	A	C2
D 1045	DIODE				HN2D01FUTE85R	G2070348		1-	A	C2
D 1046	DIODE				HN2D01FUTE85R	G2070348		1-	B	b2
D 1047	DIODE				1SS321 TE85R	G2070076		1-	A	A2
D 1048	DIODE				RLS135 TE-11	G2070128		1-	A	B1
D 1049	DIODE				RB751S-40TE61	G2070850		1-	B	c1
D 1050	DIODE				1SS385(TE85L)	G2070880		1-	A	A3
D 1051	DIODE				1SV307(TPH3)	G2070638		1-	A	B2
D 1052	DIODE				1SV271 TPH3	G2070476		1-	A	A1
D 1053	DIODE				RLS135 TE-11	G2070128		1-	B	c1
D 1054	DIODE				1SV307(TPH3)	G2070638		1-	B	c1
D 1055	DIODE				RB751S-40TE61	G2070850		1-	B	c1
D 1056	DIODE				1SV271 TPH3	G2070476		1-	B	c1
D 1057	DIODE				1SV271 TPH3	G2070476		1-	B	c1
D 1058	DIODE				RLS135 TE-11	G2070128		1-	B	c1
D 1059	DIODE				1SV307(TPH3)	G2070638		1-	B	c2
D 1060	DIODE				1SS400 TE61	G2070634		1-	A	A3

REF.	DESCRIPTION	VALUE	V/W	TOL.	MFR'S DESIG	VXSTD P/N	VERS.	LOT.	SIDE	LAY ADR.
D 1061	DIODE				RB751S-40TE61	G2070850		1-	B	d1
D 1062	DIODE				1SV271 TPH3	G2070476		1-	A	A1
D 1063	DIODE				DAN222 TL	G2070174		1-	B	b2
D 1064	DIODE				1SS400 TE61	G2070634		1-	B	a2
FB1001	CHIP COIL				BLM21P300SPT	L1690840		1-	A	C3
HS1001	HEATSINK PLATE					RA0395500		1-	B	b1
J 1006	CONNECTOR				AXK6F10335P	P0091225		1-	B	c2
J 1007	CONNECTOR				AXK6F10335P	P0091225		1-	B	b2
J 1008	CONNECTOR				IL-FPR-33S-VF-E1500	P1091138		1-	A	A2
L 1001	M.RFC	0.01uH			ELJ-RF10NJF2	L1690831		1-	A	A1
L 1002	M.RFC	0.56uH			LK1608 R56K-T	L1690415		1-	B	d2
L 1003	M.RFC	0.0082uH			TFL0510-8N2	L1690810		1-	A	A1
L 1004	M.RFC	0.01uH			ELJ-RF10NJF2	L1690831		1-	A	A1
L 1005	M.RFC	0.033uH		2%	C1608CA-33NG	L1691038		1-	A	B1
L 1006	M.RFC	0.0068uH		5%	C1608CA-6N8J	L1691093		1-	A	B1
L 1007	M.RFC	0.01uH		2%	C1608CA-10NG	L1691032		1-	A	B1
L 1008	M.RFC	0.15uH			LK1608 R15K-T	L1690409		1-	B	c2
L 1009	M.RFC	0.056uH			HK1608 56NJ-T	L1690525		1-	B	c2
L 1010	M.RFC	0.15uH			LK1608 R15K-T	L1690409		1-	B	c2
L 1011	M.RFC	0.15uH		2%	C1608CA-R15G	L1691101		1-	B	c2
L 1012	M.RFC	0.068uH			LK1608 68NM-T	L1690406		1-	B	c2
L 1013	M.RFC	33uH			LK1608 330M-T	L1690690		1-	B	c2
L 1014	M.RFC	120uH			FLC32T-121J	L1690228		1-	B	d2
L 1015	M.RFC	27uH			LK1608 270M-T	L1691031		1-	B	d2
L 1016	M.RFC	2.2uH			LK1608 2R2K-T	L1690634		1-	B	d2
L 1017	M.RFC	33uH			LK1608 330M-T	L1690690		1-	B	d2
L 1018	M.RFC	0.0056uH			TFL0510-5N6	L1690808		1-	A	A2
L 1019	M.RFC	0.0056uH			TFL0510-5N6	L1690808		1-	A	A2
L 1020	M.RFC	0.01uH		2%	C1608CA-10NG	L1691032		1-	A	B2
L 1021	M.RFC	0.01uH		2%	C1608CA-10NG	L1691032		1-	A	B2
L 1022	M.RFC	0.018uH		2%	C1608CA-18NG	L1691035		1-	A	B2
L 1023	M.RFC	0.082uH		2%	C1608CA-82NG	L1691044		1-	B	b2
L 1025	M.RFC	0.082uH		2%	C1608CA-82NG	L1691044		1-	B	b2
L 1026	M.RFC	0.082uH		2%	C1608CA-82NG	L1691044		1-	B	b2
L 1027	M.RFC	0.015uH		2%	C1608CA-15NG	L1691034		1-	B	c2
L 1028	M.RFC	0.039uH		2%	C1608CA-39NG	L1691039		1-	B	b2
L 1029	M.RFC	0.1uH		2%	C1608CA-R10G	L1691045		1-	B	b2
L 1030	M.RFC	0.072uH		2%	C1608CA-72NG	L1691043		1-	B	b3
L 1031	M.RFC	0.33uH		2%	C1608CA-R33G	L1691106		1-	B	c3
L 1032	M.RFC	0.22uH		5%	C1608CA-R22J	L1691068		1-	B	c2
L 1033	M.RFC	0.22uH		5%	C1608CA-R22J	L1691068		1-	B	c3
L 1034	M.RFC	0.33uH		2%	C1608CA-R33G	L1691106		1-	B	c3
L 1035	M.RFC	0.072uH		2%	C1608CA-72NG	L1691043		1-	B	c2
L 1036	M.RFC	0.072uH		2%	C1608CA-72NG	L1691043		1-	B	c2
L 1037	M.RFC	0.01uH			ELJ-RF10NJF2	L1690831		1-	A	B2
L 1038	M.RFC	0.01uH		2%	C1608CA-10NG	L1691032		1-	A	B2
L 1039	M.RFC	0.018uH		2%	C1608CA-18NG	L1691035		1-	A	B2
L 1040	M.RFC	0.033uH		2%	C1608CA-33NG	L1691038		1-	A	B2
L 1041	M.RFC	0.022uH			TFL0510-22N	L1690815		1-	A	C2
L 1042	M.RFC	0.022uH			TFL0510-22N	L1690815		1-	A	C2
L 1043	M.RFC	1uH			LK1608 1R0K-T	L1690687		1-	A	C2
L 1044	M.RFC	470uH			FLC32T-471J	L1690235		1-	B	a3
L 1045	M.RFC	0.027uH			TFL0510-27N	L1690816		1-	A	C2
L 1046	M.RFC	0.015uH			TFL0510-15N	L1690813		1-	A	D1
L 1047	CHIP COIL	0.047uH			LQN21A47NJ04	L1690617		1-	A	C1
L 1048	M.RFC	0.22uH			LK1608 R22K-T	L1690410		1-	A	C1
L 1049	M.RFC	0.022uH			ELJ-RE22NJF2	L1690718	USA	1-	A	C1
L 1049	M.RFC	0.033uH			ELJ-RE33NJF2	L1690720	EXPORT	1-	A	C1
L 1049	M.RFC	0.022uH			ELJ-RE22NJF2	L1690718	EXPORT	2-	A	C1
L 1049	M.RFC	0.033uH			ELJ-RE33NJF2	L1690720	GERMANY	1-	A	C1

# RF Unit

REF.	DESCRIPTION	VALUE	V/W	TOL.	MFR'S DESIG	VXSTD P/N	VERS.	LOT.	SIDE	LAY ADR.
L 1050	M.RFC	0.1uH		2%	C1608CA-R10G	L1691045		1-	A	C1
L 1051	COIL				E2 0.25-1.85-8.5T-L	L0022576		1-	A	C1
L 1052	COIL				E2 0.4-1.3-2T-L	L0022580		1-	A	B2
L 1053	M.RFC	4.7uH			LK1608 4R7K-T	L1690688		1-	A	B1
L 1054	COIL				E2 0.5-1.4-2.5T-L	L0022750		1-	B	b1
L 1055	COIL				E2 0.5-1.4-2.5T-L	L0022750		1-	B	b1
L 1056	M.RFC	4.7uH			LK1608 4R7K-T	L1690688		1-	B	c1
L 1057	COIL				E2 0.28-1.0-11TR	L0022426		1-	B	b1
L 1058	M.RFC	4.7uH			LK1608 4R7K-T	L1690688		1-	B	c1
L 1059	COIL				E2 0.35-1.4-3.5T-L-B	L0022729		1-	A	A1
L 1060	COIL				E2 0.35-1.4-3.5T-L-B	L0022729		1-	A	A1
L 1061	COIL				E2 0.35-1.6-4T-L	L0022456		1-	A	A1
L 1062	COIL				E2 0.35-1.6-7T-L	L0022390		1-	B	c1
L 1063	COIL				E2 0.35-1.6-7T-L	L0022390		1-	B	c1
L 1064	COIL				E2 0.35-1.6-7T-L	L0022390		1-	B	c1
L 1065	CHIP COIL	0.22uH			LQN21AR22J04	L1690600		1-	B	c2
L 1066	COIL				E2 0.25-1.85-8.5T-L	L0022576		1-	B	d1
L 1067	COIL				E2 0.35-1.6-4T-L	L0022456		1-	A	A1
L 1068	COIL				E2 0.35-1.6-4T-L	L0022456		1-	A	A1
L 1069	COIL				E2 0.3-1.7-7T-R	L0022372		1-	B	c1
L 1070	COIL				E2 0.35-1.6-7T-L	L0022390		1-	B	d1
L 1071	COIL				E2 0.25-1.9-10.5T-L	L0022749		1-	B	d1
L 1072	M.RFC	0.0068uH		5%	C1608CA-6N8J	L1691093		1-	A	C1
L 1073	M.RFC	0.0082uH			HK1608 8N2J-T	L1690515		1-	A	B2
L 1074	M.RFC	0.012uH			TFL0510-12N	L1690812		1-	A	B2
L 1075	M.RFC	0.012uH			TFL0510-12N	L1690812		1-	A	B2
NF1001	EMI FILTER				NFM4516P13C204FT1	Q9000759		1-	A	C3
Q 1001	TRANSISTOR				DTC144EE TL	G3070075		1-	A	A2
Q 1002	TRANSISTOR				2SC5277-D2-TL	G3352778B		1-	A	A2
Q 1003	TRANSISTOR				2SC5555ZD-TR	G3355557		1-	A	B1
Q 1004	TRANSISTOR				2SC5555ZD-TR	G3355557		1-	B	c2
Q 1005	TRANSISTOR				2SC5555ZD-TR	G3355557		1-	B	c2
Q 1006	TRANSISTOR				2SC5555ZD-TR	G3355557		1-	A	B2
Q 1007	TRANSISTOR				2SC5555ZD-TR	G3355557		1-	A	B2
Q 1008	TRANSISTOR				2SC4915-O(TE85L)	G3349158O		1-	B	c3
Q 1009	TRANSISTOR				2SC4915-O(TE85L)	G3349158O		1-	B	d3
Q 1010	TRANSISTOR				2SC5277-D2-TL	G3352778B		1-	A	A2
Q 1011	TRANSISTOR				2SC5555ZD-TR	G3355557		1-	A	C2
Q 1012	TRANSISTOR				2SC5555ZD-TR	G3355557		1-	B	b2
Q 1013	TRANSISTOR				2SC4915-O(TE85L)	G3349158O		1-	B	c3
Q 1014	TRANSISTOR				2SC5226-5-TL	G3352268E		1-	A	C2
Q 1015	TRANSISTOR				UMD6N TR	G3070215		1-	A	C2
Q 1016	TRANSISTOR				2SC5374-TL	G3353748		1-	A	C2
Q 1017	TRANSISTOR				2SC5374-TL	G3353748		1-	B	b2
Q 1018	TRANSISTOR				2SC5374-TL	G3353748		1-	B	b2
Q 1019	IC				MB15A01PFV1-G-BND-EF	G1092545		1-	B	b2
Q 1020	TRANSISTOR				2SC4915-O(TE85L)	G3349158O		1-	B	a2
Q 1021	TRANSISTOR				DTA144EE TL	G3070074		1-	B	a2
Q 1022	IC				NJM12902V(TE1)	G1093592		1-	A	D1
Q 1023	FET				2SK3475(TE12L)	G3834758		1-	A	C1
Q 1024	TRANSISTOR				2SC5226-5-TL	G3352268E		1-	A	C1
Q 1025	TRANSISTOR				DTC143ZE TL	G3070102		1-	A	C2
Q 1026	TRANSISTOR				DTC144EE TL	G3070075		1-	B	a1
Q 1027	FET				2SK3476(TE12L)	G3834768		1-	A	C1
Q 1028	TRANSISTOR				KRA760U-RTK	G3070278		1-	A	C2
Q 1029	TRANSISTOR				DTC144EE TL	G3070075		1-	A	C2
Q 1030	TRANSISTOR				DTC144EE TL	G3070075		1-	A	C2
Q 1031	FET				HN1J02FU(TE85L)	G3070221		1-	B	a1
Q 1032	TRANSISTOR				2SC4154-T11-1E	G3341548E		1-	A	A3
Q 1033	TRANSISTOR				2SA1774 TL R	G3117748R		1-	A	A3



REF.	DESCRIPTION	VALUE	V/W	TOL.	MFR'S DESIG	VXSTD P/N	VERS.	LOT.	SIDE	LAY ADR.
Q 1034	TRANSISTOR				DTC144EE TL	G3070075		1-	A	B2
Q 1035	TRANSISTOR				DTC144EE TL	G3070075		1-	A	A1
Q 1036	TRANSISTOR				2SA1774 TL R	G3117748R		1-	A	A3
Q 1037	TRANSISTOR				KRA760U-RTK	G3070278		1-	A	B2
Q 1038	TRANSISTOR				2SA1774 TL R	G3117748R		1-	B	a1
Q 1039	TRANSISTOR				KRA760U-RTK	G3070278		1-	A	B2
Q 1040	TRANSISTOR				KRC654U-RTK	G3070290		1-	A	B3
Q 1041	TRANSISTOR				KRA760U-RTK	G3070278		1-	A	B2
Q 1042	TRANSISTOR				DTC144EE TL	G3070075		1-	B	c1
Q 1043	TRANSISTOR				CPH6102-TL	G3070223		1-	B	a1
Q 1044	TRANSISTOR				UMW1 TR	G3070078		1-	B	a1
Q 1045	TRANSISTOR				KRA760U-RTK	G3070278		1-	B	a1
Q 1046	TRANSISTOR				2SA1774 TL R	G3117748R		1-	B	a1
Q 1047	TRANSISTOR				KRA755U-RTK	G3070292		1-	A	C2
Q 1048	TRANSISTOR				KRC654U-RTK	G3070290		1-	B	a1
Q 1049	TRANSISTOR				KRC654U-RTK	G3070290		1-	A	D2
Q 1050	TRANSISTOR				KRA760U-RTK	G3070278		1-	A	C2
Q 1051	TRANSISTOR				DTC144EE TL	G3070075		1-	A	C2
Q 1052	TRANSISTOR				2SA1774 TL R	G3117748R		1-	A	C2
Q 1053	TRANSISTOR				DTC144EE TL	G3070075		1-	A	C1
Q 1054	TRANSISTOR				DTC144TE-TL	G3070280		1-	B	a1
R 1001	CHIP RES.	1k	1/16W	5%	RMC1/16S 102JTH	J24189025		1-	A	B2
R 1002	CHIP RES.	1k	1/16W	5%	RMC1/16S 102JTH	J24189025		1-	B	c2
R 1003	CHIP RES.	1.5k	1/16W	5%	RMC1/16S 152JTH	J24189027		1-	B	c2
R 1005	CHIP RES.	1k	1/16W	5%	RMC1/16S 102JTH	J24189025		1-	A	A1
R 1006	CHIP RES.	3.3k	1/16W	5%	RMC1/16S 332JTH	J24189031		1-	A	A2
R 1007	CHIP RES.	47k	1/16W	5%	RMC1/16S 473JTH	J24189045		1-	A	A2
R 1008	CHIP RES.	220	1/16W	5%	RMC1/16S 221JTH	J24189017		1-	A	A2
R 1009	CHIP RES.	47k	1/16W	5%	RMC1/16S 473JTH	J24189045		1-	A	B1
R 1010	CHIP RES.	22	1/16W	5%	RMC1/16S 220JTH	J24189005		1-	A	B1
R 1011	CHIP RES.	22	1/16W	5%	RMC1/16S 220JTH	J24189005		1-	A	B1
R 1012	CHIP RES.	220	1/16W	5%	RMC1/16S 221JTH	J24189017		1-	A	B1
R 1013	CHIP RES.	22k	1/16W	5%	RMC1/16S 223JTH	J24189041		1-	B	c2
R 1014	CHIP RES.	22	1/16W	5%	RMC1/16S 220JTH	J24189005		1-	B	c2
R 1015	CHIP RES.	22	1/16W	5%	RMC1/16S 220JTH	J24189005		1-	B	c2
R 1016	CHIP RES.	4.7k	1/16W	5%	RMC1/16S 472JTH	J24189033		1-	B	c2
R 1017	CHIP RES.	47	1/16W	5%	RMC1/16S 470JTH	J24189009		1-	B	c2
R 1018	CHIP RES.	47k	1/16W	5%	RMC1/16S 473JTH	J24189045		1-	B	c2
R 1019	CHIP RES.	220	1/16W	5%	RMC1/16S 221JTH	J24189017		1-	B	d2
R 1020	CHIP RES.	1k	1/16W	5%	RMC1/16S 102JTH	J24189025		1-	B	d2
R 1021	CHIP RES.	1k	1/16W	5%	RMC1/16S 102JTH	J24189025		1-	B	d2
R 1022	CHIP RES.	2.2k	1/16W	5%	RMC1/16S 222JTH	J24189029		1-	B	d3
R 1023	CHIP RES.	100k	1/16W	5%	RMC1/16S 104JTH	J24189049		1-	B	d2
R 1024	CHIP RES.	1k	1/16W	5%	RMC1/16S 102JTH	J24189025		1-	B	d3
R 1025	CHIP RES.	100k	1/16W	5%	RMC1/16S 104JTH	J24189049		1-	A	B2
R 1027	CHIP RES.	100k	1/16W	5%	RMC1/16S 104JTH	J24189049		1-	A	B2
R 1028	CHIP RES.	100k	1/16W	5%	RMC1/16S 104JTH	J24189049		1-	A	B2
R 1029	CHIP RES.	100k	1/16W	5%	RMC1/16S 104JTH	J24189049		1-	A	B2
R 1030	CHIP RES.	22k	1/16W	5%	RMC1/16S 223JTH	J24189041		1-	A	B2
R 1031	CHIP RES.	100	1/16W	5%	RMC1/16S 101JTH	J24189013		1-	A	B2
R 1032	CHIP RES.	100k	1/16W	5%	RMC1/16S 104JTH	J24189049		1-	B	b2
R 1033	CHIP RES.	10k	1/16W	5%	RMC1/16S 103JTH	J24189037		1-	A	B2
R 1034	CHIP RES.	100	1/16W	5%	RMC1/16S 101JTH	J24189013		1-	A	B2
R 1035	CHIP RES.	100k	1/16W	5%	RMC1/16S 104JTH	J24189049		1-	B	c2
R 1036	CHIP RES.	22	1/16W	5%	RMC1/16S 220JTH	J24189005		1-	B	c2
R 1037	CHIP RES.	22	1/16W	5%	RMC1/16S 220JTH	J24189005		1-	B	c2
R 1038	CHIP RES.	100k	1/16W	5%	RMC1/16S 104JTH	J24189049		1-	B	b2
R 1039	CHIP RES.	100k	1/16W	5%	RMC1/16S 104JTH	J24189049		1-	B	b2
R 1040	CHIP RES.	330k	1/16W	5%	RMC1/16S 334JTH	J24189055		1-	B	c3
R 1042	CHIP RES.	100k	1/16W	5%	RMC1/16S 104JTH	J24189049		1-	B	c3

# RF Unit

REF.	DESCRIPTION	VALUE	V/W	TOL.	MFR'S DESIG	VXSTD P/N	VERS.	LOT.	SIDE	LAY ADR.
R 1043	CHIP RES.	100k	1/16W	5%	RMC1/16S 104JTH	J24189049		1-	B	c3
R 1044	CHIP RES.	1k	1/16W	5%	RMC1/16S 102JTH	J24189025		1-	B	d3
R 1045	CHIP RES.	47k	1/16W	5%	RMC1/16S 473JTH	J24189045		1-	B	d3
R 1046	CHIP RES.	330	1/16W	5%	RMC1/16S 331JTH	J24189019		1-	B	d3
R 1049	CHIP RES.	330k	1/16W	5%	RMC1/16S 334JTH	J24189055		1-	A	A2
R 1050	CHIP RES.	470	1/16W	5%	RMC1/16S 471JTH	J24189021		1-	A	A2
R 1051	CHIP RES.	100k	1/16W	5%	RMC1/16S 104JTH	J24189049		1-	A	B2
R 1052	CHIP RES.	1k	1/16W	5%	RMC1/16S 102JTH	J24189025		1-	A	A2
R 1052	CHIP RES.	220	1/16W	5%	RMC1/16S 221JTH	J24189017		2-	A	A2
R 1053	CHIP RES.	100k	1/16W	5%	RMC1/16S 104JTH	J24189049		1-	A	B2
R 1054	CHIP RES.	330k	1/16W	5%	RMC1/16S 334JTH	J24189055		1-	A	C2
R 1055	CHIP RES.	220	1/16W	5%	RMC1/16S 221JTH	J24189017		1-	A	C2
R 1056	CHIP RES.	470	1/16W	5%	RMC1/16S 471JTH	J24189021		1-	A	C2
R 1057	CHIP RES.	220	1/16W	5%	RMC1/16S 221JTH	J24189017		1-	A	B2
R 1058	CHIP RES.	100k	1/16W	5%	RMC1/16S 104JTH	J24189049		1-	B	b2
R 1059	CHIP RES.	220	1/16W	5%	RMC1/16S 221JTH	J24189017		1-	B	b2
R 1060	CHIP RES.	330	1/16W	5%	RMC1/16S 331JTH	J24189019		1-	B	b2
R 1061	CHIP RES.	220	1/16W	5%	RMC1/16S 221JTH	J24189017		1-	B	b3
R 1062	CHIP RES.	100k	1/16W	5%	RMC1/16S 104JTH	J24189049		1-	B	b2
R 1063	CHIP RES.	220	1/16W	5%	RMC1/16S 221JTH	J24189017		1-	B	c3
R 1064	CHIP RES.	330	1/16W	5%	RMC1/16S 331JTH	J24189019		1-	B	c3
R 1065	CHIP RES.	2.2k	1/16W	5%	RMC1/16S 222JTH	J24189029		1-	B	c3
R 1066	CHIP RES.	330k	1/16W	5%	RMC1/16S 334JTH	J24189055		1-	B	c3
R 1067	CHIP RES.	330	1/16W	5%	RMC1/16S 331JTH	J24189019		1-	B	c3
R 1068	CHIP RES.	100	1/16W	5%	RMC1/16S 101JTH	J24189013		1-	B	c3
R 1069	CHIP RES.	1k	1/16W	5%	RMC1/16S 102JTH	J24189025	EXPORT	1-	A	C2
R 1069	CHIP RES.	680	1/16W	5%	RMC1/16S 681JTH	J24189023	EXPORT	2-	A	C2
R 1069	CHIP RES.	680	1/16W	5%	RMC1/16S 681JTH	J24189023	USA	1-	A	C2
R 1069	CHIP RES.	1k	1/16W	5%	RMC1/16S 102JTH	J24189025	GERMANY	1-	A	C2
R 1070	CHIP RES.	100	1/16W	5%	RMC1/16S 101JTH	J24189013		1-	A	C2
R 1071	CHIP RES.	1k	1/16W	5%	RMC1/16S 102JTH	J24189025		1-	A	C3
R 1072	CHIP RES.	1k	1/16W	5%	RMC1/16S 102JTH	J24189025		1-	A	C3
R 1073	CHIP RES.	1k	1/16W	5%	RMC1/16S 102JTH	J24189025		1-	A	C3
R 1074	CHIP RES.	330k	1/16W	5%	RMC1/16S 334JTH	J24189055		1-	B	a2
R 1075	CHIP RES.	100k	1/16W	5%	RMC1/16S 104JTH	J24189049		1-	B	a2
R 1076	CHIP RES.	100k	1/16W	5%	RMC1/16S 104JTH	J24189049		1-	B	a2
R 1077	CHIP RES.	1M	1/16W	5%	RMC1/16S 105JTH	J24189061		1-	B	a2
R 1078	CHIP RES.	10k	1/16W	5%	RMC1/16S 103JTH	J24189037		1-	A	C2
R 1079	CHIP RES.	470	1/16W	5%	RMC1/16S 471JTH	J24189021		1-	A	C2
R 1080	CHIP RES.	1k	1/16W	5%	RMC1/16S 102JTH	J24189025		1-	A	C2
R 1081	CHIP RES.	47	1/16W	5%	RMC1/16S 470JTH	J24189009		1-	A	C2
R 1082	CHIP RES.	10k	1/16W	5%	RMC1/16S 103JTH	J24189037		1-	A	C2
R 1083	CHIP RES.	33k	1/16W	5%	RMC1/16S 333JTH	J24189043		1-	B	b2
R 1084	CHIP RES.	33k	1/16W	5%	RMC1/16S 333JTH	J24189043		1-	B	b2
R 1085	CHIP RES.	100	1/16W	5%	RMC1/16S 101JTH	J24189013		1-	A	C2
R 1086	CHIP RES.	1.5k	1/16W	5%	RMC1/16S 152JTH	J24189027		1-	B	a3
R 1087	CHIP RES.	1k	1/16W	5%	RMC1/16S 102JTH	J24189025		1-	B	a2
R 1088	CHIP RES.	330k	1/16W	5%	RMC1/16S 334JTH	J24189055		1-	B	a2
R 1089	CHIP RES.	1.8k	1/16W	5%	RMC1/16S 182JTH	J24189028		1-	B	a3
R 1090	CHIP RES.	1.8k	1/16W	5%	RMC1/16S 182JTH	J24189028	GERMANY	1-	B	a3
R 1090	CHIP RES.	1k	1/16W	5%	RMC1/16S 102JTH	J24189025	USA	1-	B	a3
R 1090	CHIP RES.	1.8k	1/16W	5%	RMC1/16S 182JTH	J24189028	EXPORT	1-	B	a3
R 1090	CHIP RES.	1k	1/16W	5%	RMC1/16S 102JTH	J24189025	EXPORT	2-	B	a3
R 1091	CHIP RES.	1k	1/16W	5%	RMC1/16S 102JTH	J24189025		1-	B	b3
R 1092	CHIP RES.	47	1/16W	5%	RMC1/16S 470JTH	J24189009		1-	A	C2
R 1093	CHIP RES.	27k	1/16W	5%	RMC1/16S 273JTH	J24189042		1-	A	D1
R 1094	CHIP RES.	10k	1/16W	5%	RMC1/16S 103JTH	J24189037		1-	A	D1
R 1095	CHIP RES.	470	1/16W	5%	RMC1/16S 471JTH	J24189021		1-	A	D1
R 1096	CHIP RES.	10k	1/16W	5%	RMC1/16S 103JTH	J24189037		1-	A	D2
R 1097	CHIP RES.	220k	1/16W	5%	RMC1/16S 224JTH	J24189053		1-	A	D1

REF.	DESCRIPTION	VALUE	V/W	TOL.	MFR'S DESIG	VXSTD P/N	VERS.	LOT.	SIDE	LAY ADR.
R 1098	CHIP RES.	100	1/16W	5%	RMC1/16S 101JTH	J24189013		1-	A	C1
R 1099	CHIP RES.	10k	1/16W	5%	RMC1/16S 103JTH	J24189037		1-	A	C1
R 1100	CHIP RES.	330	1/16W	5%	RMC1/16S 331JTH	J24189019		1-	A	C1
R 1102	CHIP RES.	3.3k	1/16W	5%	RMC1/16S 332JTH	J24189031		1-	B	a3
R 1103	CHIP RES.	2.2k	1/16W	5%	RMC1/16S 222JTH	J24189029	GERMANY	1-	B	a3
R 1103	CHIP RES.	1.5k	1/16W	5%	RMC1/16S 152JTH	J24189027	USA	1-	B	a3
R 1103	CHIP RES.	2.2k	1/16W	5%	RMC1/16S 222JTH	J24189029	EXPORT	1-	B	a3
R 1103	CHIP RES.	1.5k	1/16W	5%	RMC1/16S 152JTH	J24189027	EXPORT	2-	B	a3
R 1104	CHIP RES.	1k	1/16W	5%	RMC1/16S 102JTH	J24189025		1-	B	b3
R 1105	CHIP RES.	12k	1/16W	5%	RMC1/16S 123JTH	J24189038		1-	B	a1
R 1106	CHIP RES.	15k	1/16W	5%	RMC1/16S 153JTH	J24189039		1-	B	a1
R 1107	CHIP RES.	100	1/16W	5%	RMC1/16S 101JTH	J24189013		1-	A	C1
R 1108	CHIP RES.	4.7k	1/16W	5%	RMC1/16S 472JTH	J24189033		1-	A	C1
R 1109	CHIP RES.	47	1/16W	5%	RMC1/16S 470JTH	J24189009		1-	A	C2
R 1110	CHIP RES.	2.7k	1/16W	5%	RMC1/16S 272JTH	J24189030		1-	A	D2
R 1111	CHIP RES.	100k	1/16W	5%	RMC1/16S 104JTH	J24189049		1-	B	a2
R 1112	CHIP RES.	10k	1/16W	5%	RMC1/16S 103JTH	J24189037		1-	B	a2
R 1113	CHIP RES.	47k	1/16W	5%	RMC1/16S 473JTH	J24189045		1-	B	a2
R 1114	CHIP RES.	10k	1/16W	5%	RMC1/16S 103JTH	J24189037		1-	B	a2
R 1115	CHIP RES.	47k	1/16W	5%	RMC1/16S 473JTH	J24189045		1-	B	a2
R 1116	CHIP RES.	10k	1/16W	5%	RMC1/16S 103JTH	J24189037		1-	B	a1
R 1118	CHIP RES.	330	1/16W	5%	RMC1/16S 331JTH	J24189019		1-	A	B1
R 1119	CHIP RES.	3.3k	1/16W	5%	RMC1/16S 332JTH	J24189031		1-	B	c1
R 1120	CHIP RES.	330	1/16W	5%	RMC1/16S 331JTH	J24189019		1-	B	c1
R 1121	CHIP RES.	330	1/16W	5%	RMC1/16S 331JTH	J24189019		1-	B	c2
R 1122	CHIP RES.	10k	1/16W	5%	RMC1/16S 103JTH	J24189037		1-	B	a2
R 1123	CHIP RES.	4.7k	1/16W	5%	RMC1/16S 472JTH	J24189033		1-	B	a1
R 1124	CHIP RES.	3.3k	1/16W	5%	RMC1/16S 332JTH	J24189031		1-	B	a1
R 1125	CHIP RES.	1k	1/16W	5%	RMC1/16S 102JTH	J24189025		1-	A	A3
R 1126	CHIP RES.	100k	1/16W	5%	RMC1/16S 104JTH	J24189049		1-	B	a1
R 1127	CHIP RES.	4.7k	1/16W	5%	RMC1/16S 472JTH	J24189033		1-	A	A3
R 1128	CHIP RES.	3.3k	1/16W	5%	RMC1/16S 332JTH	J24189031		1-	A	A1
R 1129	CHIP RES.	3.3k	1/16W	5%	RMC1/16S 332JTH	J24189031		1-	A	A1
R 1130	CHIP RES.	330	1/16W	5%	RMC1/16S 331JTH	J24189019		1-	B	c1
R 1131	CHIP RES.	10k	1/16W	5%	RMC1/16S 103JTH	J24189037		1-	B	c1
R 1132	CHIP RES.	4.7k	1/16W	5%	RMC1/16S 472JTH	J24189033		1-	A	A3
R 1133	CHIP RES.	1k	1/16W	5%	RMC1/16S 102JTH	J24189025		1-	B	a1
R 1134	CHIP RES.	4.7k	1/16W	5%	RMC1/16S 472JTH	J24189033		1-	B	d1
R 1135	CHIP RES.	220	1/16W	5%	RMC1/16S 221JTH	J24189017		1-	A	A1
R 1136	CHIP RES.	1k	1/16W	5%	RMC1/16S 102JTH	J24189025		1-	B	a2
R 1137	CHIP RES.	10k	1/16W	5%	RMC1/16S 103JTH	J24189037		1-	B	a2
R 1138	CHIP RES.	10k	1/16W	5%	RMC1/16S 103JTH	J24189037		1-	B	a2
R 1139	CHIP RES.	1k	1/16W	5%	RMC1/16S 102JTH	J24189025		1-	B	a1
R 1140	CHIP RES.	1k	1/16W	5%	RMC1/16S 102JTH	J24189025		1-	A	D2
R 1141	CHIP RES.	10k	1/16W	5%	RMC1/16S 103JTH	J24189037		1-	B	c1
R 1142	CHIP RES.	100	1/16W	5%	RMC1/16S 101JTH	J24189013		1-	A	C1
R 1143	CHIP RES.	10k	1/16W	5%	RMC1/16S 103JTH	J24189037		1-	A	C1
R 1144	CHIP RES.	22k	1/16W	5%	RMC1/16S 223JTH	J24189041		1-	A	C1
R 1145	CHIP RES.	0	1/16W	5%	RMC1/16 000JATP	J24185000		1-	A	B1
R 1146	CHIP RES.	220	1/16W	5%	RMC1/16S 221JTH	J24189017		1-	B	c3
R 1147	CHIP RES.	100k	1/16W	5%	RMC1/16S 104JTH	J24189049		1-	B	a1
R 1148	CHIP RES.	100k	1/16W	5%	RMC1/16S 104JTH	J24189049		1-	B	a1
R 1149	CHIP RES.	1k	1/16W	5%	RMC1/16S 102JTH	J24189025		1-	B	d2
R 1150	CHIP RES.	10k	1/16W	5%	RMC1/16S 103JTH	J24189037		1-	A	C3
R 1151	CHIP RES.	100	1/16W	5%	RMC1/16S 101JTH	J24189013		1-	A	C2
TH1001	THERMISTOR				ERTJ1V1V473J	G9090122		1-	B	a2
TH1002	THERMISTOR				ERTJ1V1V473J	G9090122		1-	A	C1
X 1001	XTAL TSS-6	11.7MHz			TSS-5032A 11.7MHZ	H0103264		1-	B	a2
	TERMINAL PLATE					RA0287100		1-		
	INSULATOR SHEET					RA0408300		1-		

***RF Unit***  
***Note:***

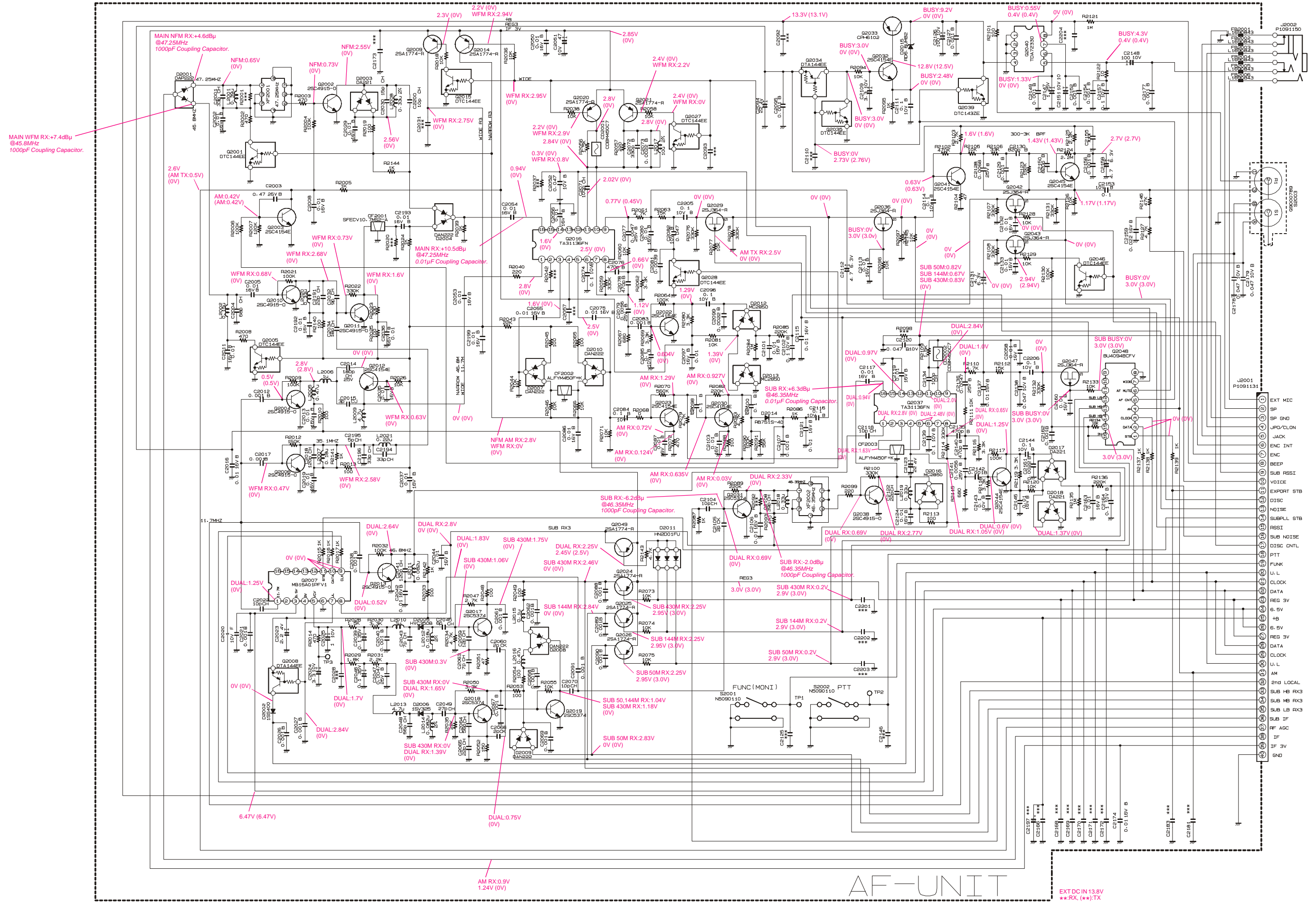

AF-UNIT

EXTDCIN13.8V  
\*\*RX, (\*\*).TX



## Parts Layout

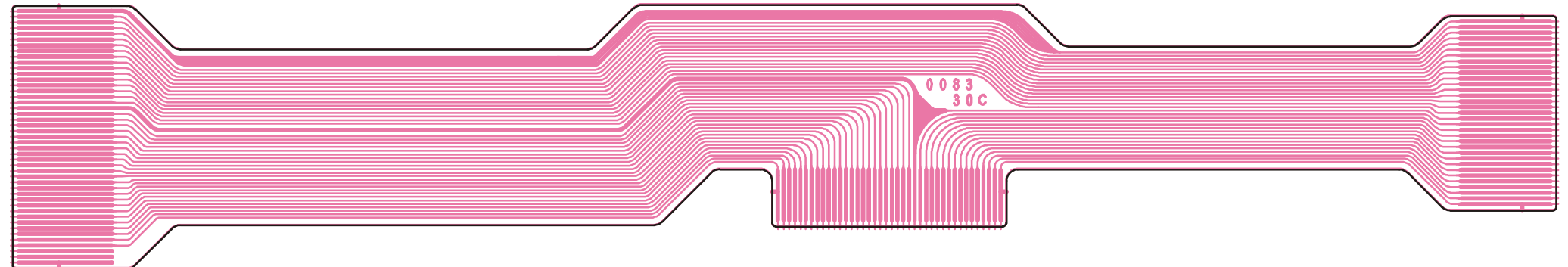
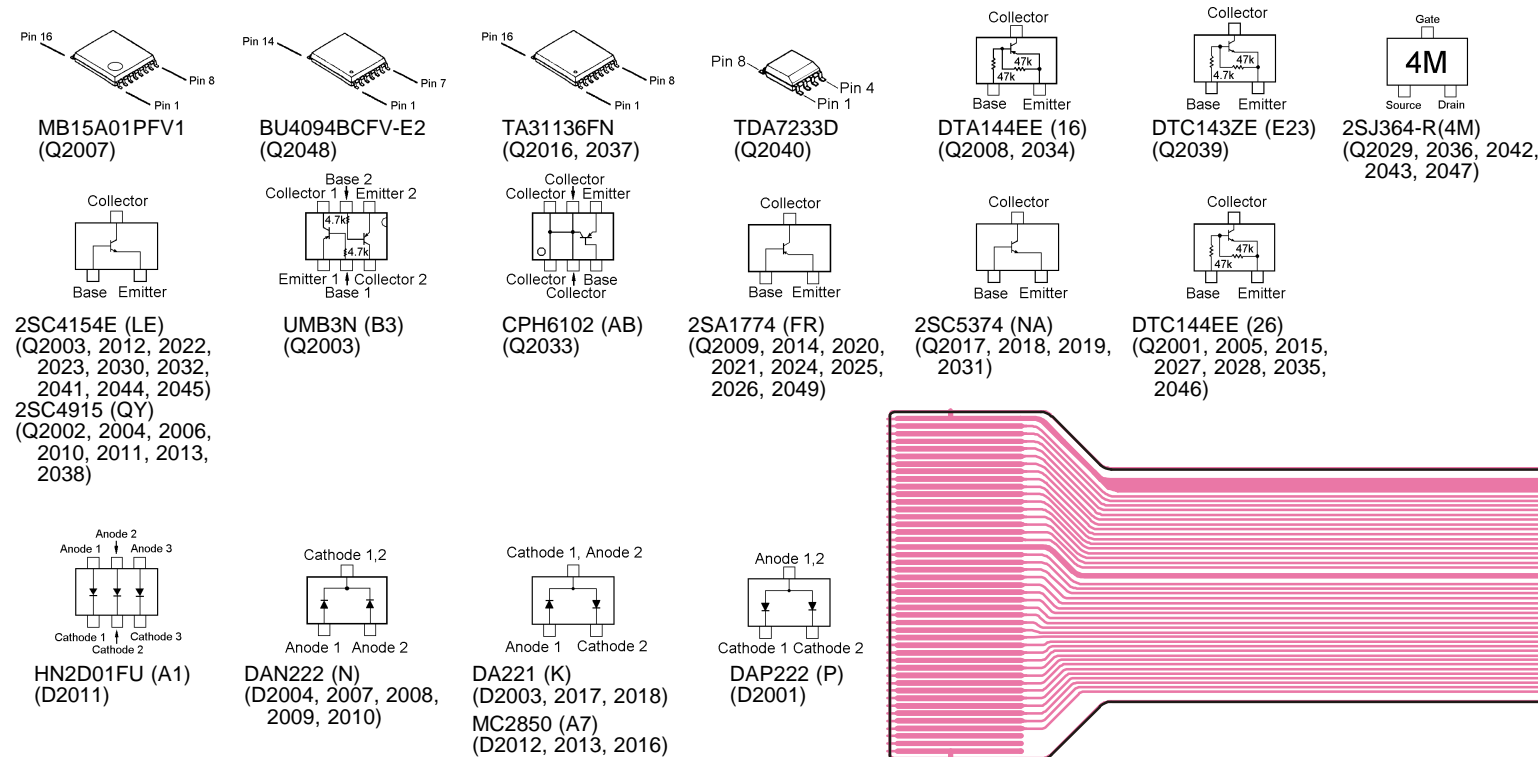
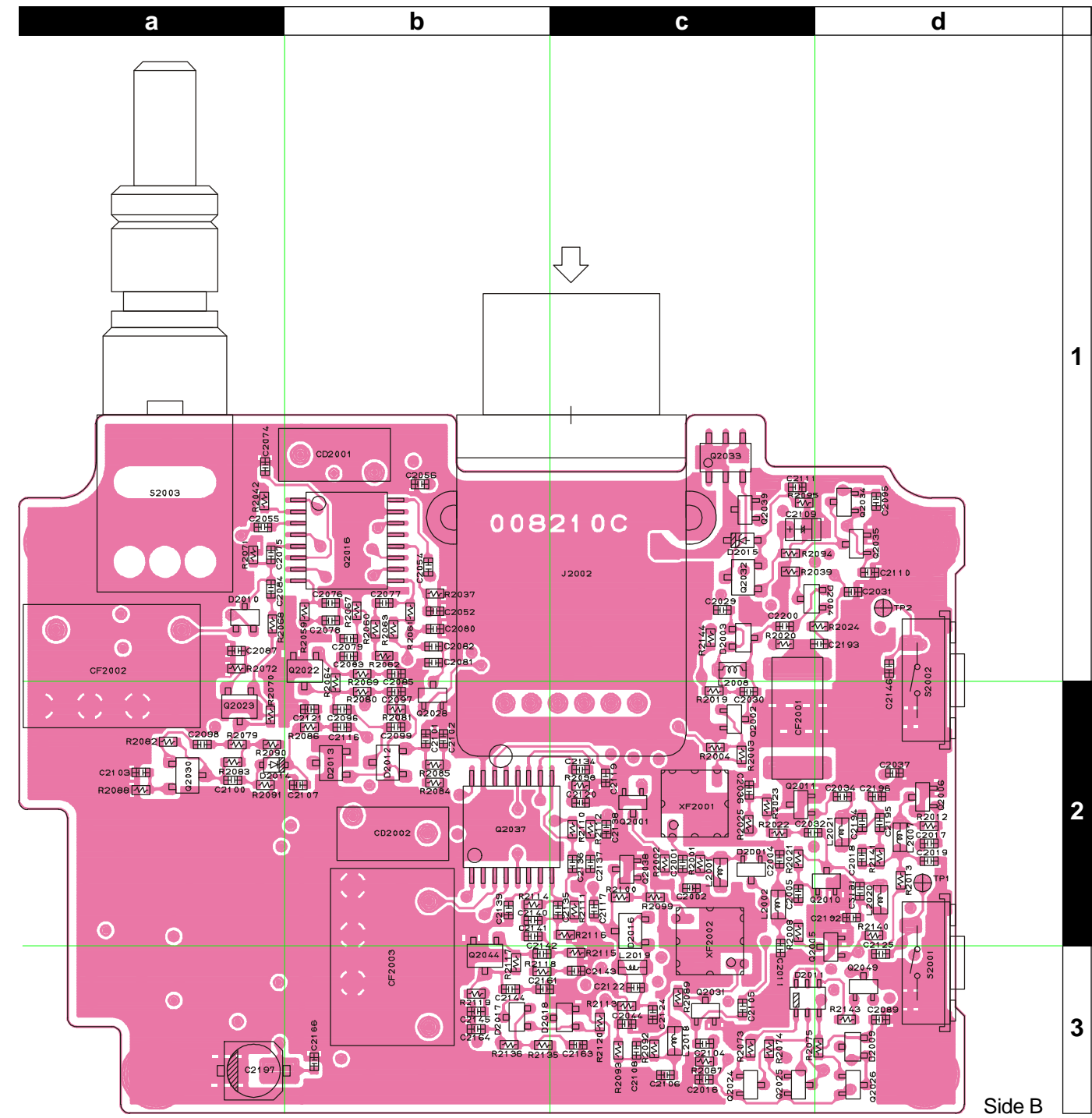
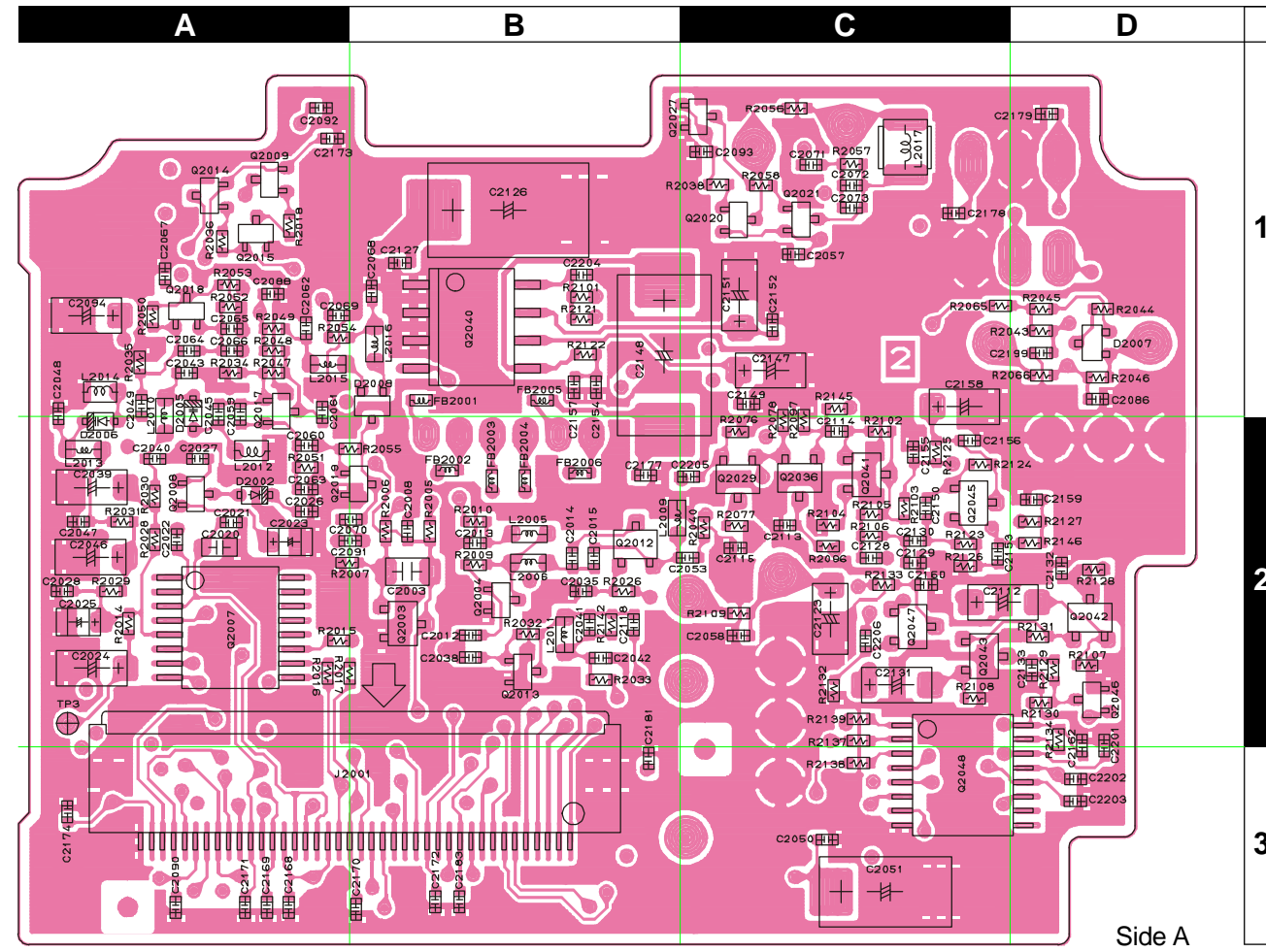

## Parts List

REF.	DESCRIPTION	VALUE	V/W	TOL.	MFR'S DESIG	VXSTD P/N	VERS.	LOT.	SIDE	LAY ADR.
*** AF UNIT ***										
PCB with Components						CB1870001				
Printed Circuit Board						FR008210C		1-		
C 2001	CHIP CAP.	33pF	50V	CH	UMK105CH330JW-F	K22178270		1-	B	c2
C 2002	CHIP CAP.	0.01uF	16V	B	GRM36B103K16PT	K22128804		1-	B	c2
C 2003	CHIP CAP.	0.47uF	25V	B	GRM40B474K25PT	K22140824		1-	A	B2
C 2004	CHIP CAP.	68pF	50V	CH	UMK105CH680JW-F	K22178278		1-	B	c2
C 2005	CHIP CAP.	0.01uF	16V	B	GRM36B103K16PT	K22128804		1-	B	c2
C 2008	CHIP CAP.	0.01uF	16V	B	GRM36B103K16PT	K22128804		1-	A	B2
C 2011	CHIP CAP.	0.01uF	16V	B	GRM36B103K16PT	K22128804		1-	B	c3
C 2012	CHIP CAP.	0.001uF	50V	B	UMK105B102KW-F	K22178829		1-	A	B2
C 2013	CHIP CAP.	0.01uF	16V	B	GRM36B103K16PT	K22128804		1-	A	B2
C 2014	CHIP CAP.	180pF	25V	CH	GRM36CH181J25PT	K22148201		1-	A	B2
C 2015	CHIP CAP.	3pF	50V	CJ	UMK105CJ030CW-F	K22178251		1-	A	B2
C 2016	CHIP CAP.	0.01uF	16V	B	GRM36B103K16PT	K22128804		1-	B	c3
C 2017	CHIP CAP.	0.001uF	50V	B	UMK105B102KW-F	K22178829		1-	B	d2
C 2018	CHIP CAP.	100pF	50V	CH	UMK105CH101JW-F	K22178282		1-	B	d2
C 2019	CHIP CAP.	0.01uF	16V	B	GRM36B103K16PT	K22128804		1-	B	d2
C 2020	CHIP CAP.	1uF	10V	F	GRM39F105Z10PT	K22105001		1-	A	A2
C 2021	CHIP CAP.	0.001uF	50V	B	UMK105B102KW-F	K22178829		1-	A	A2
C 2022	CHIP CAP.	10pF	50V	CH	UMK105CH100DW-F	K22178258		1-	A	A2
C 2023	CHIP TA.CAP.	2.2uF	4V		TESVSP0G225M-8R	K78060025		1-	A	A2
C 2024	CHIP TA.CAP.	1uF	16V		TMCSA1C105MTR	K78120023		1-	A	A2
C 2026	CHIP CAP.	0.001uF	50V	B	UMK105B102KW-F	K22178829		1-	A	A2
C 2027	CHIP CAP.	0.001uF	50V	B	UMK105B102KW-F	K22178829		1-	A	A2
C 2029	CHIP CAP.	0.01uF	16V	B	GRM36B103K16PT	K22128804		1-	B	c1
C 2030	CHIP CAP.	15pF	50V	CH	UMK105CH150JW-F	K22178262		1-	B	c2
C 2032	CHIP CAP.	12pF	50V	CH	UMK105CH120JW-F	K22178260		1-	B	c2
C 2034	CHIP CAP.	0.001uF	50V	B	UMK105B102KW-F	K22178829		1-	B	d2
C 2035	CHIP CAP.	0.01uF	16V	B	GRM36B103K16PT	K22128804		1-	A	B2
C 2036	CHIP CAP.	0.01uF	16V	B	GRM36B103K16PT	K22128804		1-	B	c2
C 2037	CHIP CAP.	0.01uF	16V	B	GRM36B103K16PT	K22128804		1-	B	d2
C 2038	CHIP CAP.	0.001uF	50V	B	UMK105B102KW-F	K22178829		1-	A	B2
C 2039	CHIP TA.CAP.	0.1uF	35V		TESVA1V104M1-8R	K78160025		1-	A	A2
C 2040	CHIP CAP.	0.001uF	50V	B	UMK105B102KW-F	K22178829		1-	A	A2
C 2041	CHIP CAP.	120pF	50V	CH	UMK105CH121JW-F	K22178284		1-	A	B2
C 2042	CHIP CAP.	0.01uF	16V	B	GRM36B103K16PT	K22128804		1-	A	B2
C 2043	CHIP CAP.	22pF	50V	CH	UMK105CH220JW-F	K22178266		1-	A	A1
C 2044	CHIP CAP.	0.01uF	16V	B	GRM36B103K16PT	K22128804		1-	B	c3
C 2045	CHIP CAP.	6pF	50V	CH	GRM36CH060B50PT	K22178293		1-	A	A2
C 2046	CHIP TA.CAP.	0.1uF	35V		TESVA1V104M1-8R	K78160025		1-	A	A2
C 2047	CHIP CAP.	0.0047uF	25V	B	GRM36B472K25PT	K22148830		1-	A	A2
C 2048	CHIP CAP.	56pF	50V	CH	UMK105CH560JW-F	K22178276		1-	A	A2
C 2049	CHIP CAP.	27pF	50V	CH	UMK105CH270JW-F	K22178268		1-	A	A2
C 2050	CHIP CAP.	0.01uF	16V	B	GRM36B103K16PT	K22128804		1-	A	C3
C 2051	CHIP TA.CAP.	47uF	10V		TEMSVC1A476M12R	K78100024		1-	A	C3
C 2052	CHIP CAP.	0.047uF	10V	B	GRM36B473K10PT	K22108801		1-	B	b1
C 2053	CHIP CAP.	0.01uF	16V	B	GRM36B103K16PT	K22128804		1-	A	C2
C 2054	CHIP CAP.	0.01uF	16V	B	GRM36B103K16PT	K22128804		1-	B	b1
C 2055	CHIP CAP.	0.01uF	16V	B	GRM36B103K16PT	K22128804		1-	B	a1
C 2056	CHIP CAP.	0.01uF	16V	B	GRM36B103K16PT	K22128804		1-	B	b1
C 2058	CHIP CAP.	0.01uF	16V	B	GRM36B103K16PT	K22128804		1-	A	C2
C 2059	CHIP CAP.	9pF	50V	CH	GRM36CH090B50PT	K22178296		1-	A	A2
C 2060	CHIP CAP.	2pF	50V	CK	UMK105CK020CW-F	K22178250		1-	A	A2
C 2061	CHIP CAP.	0.001uF	50V	B	UMK105B102KW-F	K22178829		1-	A	A2
C 2062	CHIP CAP.	0.001uF	50V	B	UMK105B102KW-F	K22178829		1-	A	A1
C 2063	CHIP CAP.	7pF	50V	CH	GRM36CH070B50PT	K22178294		1-	A	A2
C 2064	CHIP CAP.	47pF	50V	CH	UMK105CH470JW-F	K22178274		1-	A	A1
C 2065	CHIP CAP.	22pF	50V	CH	UMK105CH220JW-F	K22178266		1-	A	A1
C 2066	CHIP CAP.	2pF	50V	CK	UMK105CK020CW-F	K22178250		1-	A	A1

# AF Unit

REF.	DESCRIPTION	VALUE	V/W	TOL.	MFR'S DESIG	VXSTD P/N	VERS.	LOT.	SIDE	LAY ADR.
C 2067	CHIP CAP.	0.001uF	50V	B	UMK105B102KW-F	K22178829		1-	A	A1
C 2068	CHIP CAP.	0.001uF	50V	B	UMK105B102KW-F	K22178829		1-	A	B1
C 2069	CHIP CAP.	0.001uF	50V	B	UMK105B102KW-F	K22178829		1-	A	A1
C 2070	CHIP CAP.	10pF	50V	CH	UMK105CH100DW-F	K22178258		1-	A	B2
C 2071	CHIP CAP.	100pF	50V	CH	UMK105CH101JW-F	K22178282		1-	A	C1
C 2072	CHIP CAP.	330pF	50V	B	UMK105B331KW-F	K22178823		1-	A	C1
C 2073	CHIP CAP.	0.0022uF	50V	B	GRM36B222K50PT	K22178813		1-	A	C1
C 2074	CHIP CAP.	0.1uF	10V	B	GRM36B104K10PT	K22108802		1-	B	a1
C 2075	CHIP CAP.	0.01uF	16V	B	GRM36B103K16PT	K22128804		1-	B	a1
C 2076	CHIP CAP.	470pF	50V	B	UMK105B471KW-F	K22178825		1-	B	b1
C 2077	CHIP CAP.	0.0047uF	25V	B	GRM36B472K25PT	K22148830		1-	B	b1
C 2078	CHIP CAP.	470pF	50V	B	UMK105B471KW-F	K22178825		1-	B	b1
C 2079	CHIP CAP.	0.0056uF	25V	B	GRM36B562K50PT	K22148802		1-	B	b1
C 2080	CHIP CAP.	0.01uF	16V	B	GRM36B103K16PT	K22128804		1-	B	b1
C 2081	CHIP CAP.	0.0039uF	50V	B	UMK105B392KW-F	K22178836		1-	B	b1
C 2082	CHIP CAP.	0.047uF	10V	B	GRM36B473K10PT	K22108801		1-	B	b1
C 2083	CHIP CAP.	0.001uF	50V	B	UMK105B102KW-F	K22178829		1-	B	b1
C 2084	CHIP CAP.	0.1uF	10V	B	GRM36B104K10PT	K22108802		1-	B	a1
C 2085	CHIP CAP.	0.1uF	10V	B	GRM36B104K10PT	K22108802		1-	B	b1
C 2086	CHIP CAP.	0.01uF	16V	B	GRM36B103K16PT	K22128804		1-	A	D1
C 2087	CHIP CAP.	0.01uF	16V	B	GRM36B103K16PT	K22128804		1-	B	a1
C 2088	CHIP CAP.	0.001uF	50V	B	UMK105B102KW-F	K22178829		1-	A	A1
C 2089	CHIP CAP.	0.001uF	50V	B	UMK105B102KW-F	K22178829		1-	B	d3
C 2090	CHIP CAP.	0.001uF	50V	B	UMK105B102KW-F	K22178829		1-	A	A3
C 2091	CHIP CAP.	0.001uF	50V	B	UMK105B102KW-F	K22178829		1-	A	B2
C 2092	CHIP CAP.	0.001uF	50V	B	UMK105B102KW-F	K22178829		1-	A	A1
C 2094	CHIP TA.CAP.	22uF	4V		TEMSVA0G226M-8R	K78060023		1-	A	A1
C 2095	CHIP CAP.	0.001uF	50V	B	UMK105B102KW-F	K22178829		1-	B	d1
C 2096	CHIP CAP.	0.1uF	10V	B	GRM36B104K10PT	K22108802		1-	B	b2
C 2097	CHIP CAP.	0.01uF	16V	B	GRM36B103K16PT	K22128804		1-	B	b2
C 2098	CHIP CAP.	0.1uF	10V	B	GRM36B104K10PT	K22108802		1-	B	a2
C 2099	CHIP CAP.	0.0022uF	50V	B	UMK105B222KW-F	K22178833		1-	B	b2
C 2100	CHIP CAP.	0.1uF	10V	B	GRM36B104K10PT	K22108802		1-	B	a2
C 2101	CHIP CAP.	0.01uF	16V	B	GRM36B103K16PT	K22128804		1-	B	b2
C 2102	CHIP CAP.	0.047uF	10V	B	GRM36B473K10PT	K22108801		1-	B	b2
C 2103	CHIP CAP.	0.01uF	16V	B	GRM36B103K16PT	K22128804		1-	B	a2
C 2104	CHIP CAP.	10pF	50V	CH	UMK105CH100DW-F	K22178258		1-	B	c3
C 2105	CHIP CAP.	2pF	50V	CK	UMK105CK020CW-F	K22178250		1-	B	c3
C 2106	CHIP CAP.	0.01uF	16V	B	GRM36B103K16PT	K22128804		1-	B	c3
C 2107	CHIP CAP.	0.1uF	10V	B	GRM36B104K10PT	K22108802		1-	B	b2
C 2108	CHIP CAP.	39pF	50V	CH	UMK105CH390JW-F	K22178272		1-	B	c3
C 2109	CHIP TA.CAP.	3.3uF	10V		SKF-1A335M-RP	K78100051		1-	B	c1
C 2111	CHIP CAP.	0.1uF	10V	B	GRM36B104K10PT	K22108802		1-	B	c1
C 2112	CHIP TA.CAP.	4.7uF	6.3V		TEMSVA20J475M-8R	K78080031		1-	A	C2
C 2113	CHIP CAP.	0.01uF	16V	B	GRM36B103K16PT	K22128804		1-	A	C2
C 2114	CHIP CAP.	0.1uF	10V	B	GRM36B104K10PT	K22108802		1-	A	C2
C 2115	CHIP CAP.	0.01uF	16V	B	GRM36B103K16PT	K22128804		1-	A	C2
C 2116	CHIP CAP.	0.1uF	10V	B	GRM36B104K10PT	K22108802		1-	B	b2
C 2117	CHIP CAP.	0.01uF	16V	B	GRM36B103K16PT	K22128804		1-	B	c2
C 2118	CHIP CAP.	10pF	50V	CH	UMK105CH100DW-F	K22178258		1-	A	B2
C 2119	CHIP CAP.	0.01uF	16V	B	GRM36B103K16PT	K22128804		1-	B	c2
C 2120	CHIP CAP.	0.047uF	10V	B	GRM36B473K10PT	K22108801		1-	B	c2
C 2121	CHIP CAP.	0.01uF	16V	B	GRM36B103K16PT	K22128804		1-	B	b2
C 2122	CHIP CAP.	22pF	50V	CH	UMK105CH220JW-F	K22178266		1-	B	c3
C 2123	CHIP TA.CAP.	22uF	4V		TEMSVA0G226M-8R	K78060023		1-	A	C2
C 2124	CHIP CAP.	0.01uF	16V	B	GRM36B103K16PT	K22128804		1-	B	c3
C 2126	CHIP TA.CAP.	220uF	10V		TMCRE1A227MTR	K78100064		1-	A	B1
C 2126	CHIP TA.CAP.	330uF	10V		F931A337MNC	K78100066		2-	A	B1
C 2127	CHIP CAP.	0.001uF	50V	B	UMK105B102KW-F	K22178829		1-	A	B1
C 2128	CHIP CAP.	0.0068uF	25V	B	GRM36B682J25PT	K22148803		1-	A	C2



REF.	DESCRIPTION	VALUE	V/W	TOL.	MFR'S DESIG	VXSTD P/N	VERS.	LOT.	SIDE	LAY ADR.
C 2129	CHIP CAP.	0.001uF	50V	B	UMK105B102KW-F	K22178829		1-	A	C2
C 2130	CHIP CAP.	820pF	50V	B	GRM36B821K50PT	K22178808		1-	A	C2
C 2131	CHIP TA.CAP.	4.7uF	6.3V		TEMSVA20J475M-8R	K78080031		1-	A	C2
C 2132	CHIP CAP.	0.01uF	16V	B	GRM36B103K16PT	K22128804		1-	A	D2
C 2133	CHIP CAP.	0.01uF	16V	B	GRM36B103K16PT	K22128804		1-	A	D2
C 2134	CHIP CAP.	100pF	50V	CH	UMK105CH101JW-F	K22178282		1-	B	c2
C 2135	CHIP CAP.	470pF	50V	B	UMK105B471KW-F	K22178825		1-	B	c2
C 2136	CHIP CAP.	0.0047uF	25V	B	GRM36B472K25PT	K22148830		1-	B	c2
C 2137	CHIP CAP.	0.01uF	16V	B	GRM36B103K16PT	K22128804		1-	B	c2
C 2138	CHIP CAP.	0.047uF	10V	B	GRM36B473K10PT	K22108801		1-	B	c2
C 2139	CHIP CAP.	0.1uF	10V	B	GRM36B104K10PT	K22108802		1-	B	b2
C 2140	CHIP CAP.	470pF	50V	B	UMK105B471KW-F	K22178825		1-	B	b2
C 2141	CHIP CAP.	0.0056uF	25V	B	GRM36B562K50PT	K22148802		1-	B	b2
C 2142	CHIP CAP.	0.001uF	50V	B	UMK105B102KW-F	K22178829		1-	B	b3
C 2143	CHIP CAP.	0.1uF	10V	B	GRM36B104K10PT	K22108802		1-	B	c3
C 2144	CHIP CAP.	0.1uF	10V	B	GRM36B104K10PT	K22108802		1-	B	b3
C 2145	CHIP CAP.	0.01uF	16V	B	GRM36B103K16PT	K22128804		1-	B	b3
C 2147	CHIP TA.CAP.	1uF	25V		TEMSVA1E105M-8R	K78140013		1-	A	C1
C 2148	CHIP TA.CAP.	100uF	10V		TEMSVD1A107M12R	K78100031		1-	A	B1
C 2149	CHIP CAP.	0.001uF	50V	B	UMK105B102KW-F	K22178829		1-	A	C1
C 2150	CHIP CAP.	820pF	50V	B	GRM36B821K50PT	K22178808		1-	A	C2
C 2151	CHIP TA.CAP.	10uF	10V		TEMSVA1A106M-8R	K78100028		1-	A	C1
C 2152	CHIP CAP.	0.001uF	50V	B	UMK105B102KW-F	K22178829		1-	A	C1
C 2153	CHIP CAP.	0.1uF	10V	B	GRM36B104K10PT	K22108802		1-	A	C2
C 2154	CHIP CAP.	0.001uF	50V	B	UMK105B102KW-F	K22178829		1-	A	B1
C 2156	CHIP CAP.	0.001uF	50V	B	UMK105B102KW-F	K22178829		1-	A	C2
C 2157	CHIP CAP.	0.1uF	10V	B	GRM36B104K10PT	K22108802		1-	A	B1
C 2158	CHIP TA.CAP.	4.7uF	6.3V		TMCMA0J475MTR	K78080026		1-	A	C2
C 2159	CHIP CAP.	0.022uF	16V	B	GRM36B223K16PT	K22128806		1-	A	D2
C 2160	CHIP CAP.	0.01uF	16V	B	GRM36B103K16PT	K22128804		1-	A	C2
C 2161	CHIP CAP.	0.0022uF	50V	B	UMK105B222KW-F	K22178833		1-	B	b3
C 2162	CHIP CAP.	0.001uF	50V	B	UMK105B102KW-F	K22178829		1-	A	D3
C 2163	CHIP CAP.	0.01uF	16V	B	GRM36B103K16PT	K22128804		1-	B	c3
C 2164	CHIP CAP.	0.047uF	10V	B	GRM36B473K10PT	K22108801		1-	B	b3
C 2166	CHIP CAP.	0.001uF	50V	B	UMK105B102KW-F	K22178829		1-	B	b3
C 2168	CHIP CAP.	0.001uF	50V	B	UMK105B102KW-F	K22178829		1-	A	A3
C 2173	CHIP CAP.	0.001uF	50V	B	UMK105B102KW-F	K22178829		1-	A	A1
C 2174	CHIP CAP.	0.01uF	16V	B	GRM36B103K16PT	K22128804		1-	A	A3
C 2177	CHIP CAP.	0.001uF	50V	B	UMK105B102KW-F	K22178829		1-	A	B2
C 2178	CHIP CAP.	0.047uF	10V	B	GRM36B473K10PT	K22108801		1-	A	C1
C 2179	CHIP CAP.	0.047uF	10V	B	GRM36B473K10PT	K22108801		1-	A	D1
C 2191	CHIP CAP.	22pF	50V	CH	UMK105CH220JW-F	K22178266		1-	B	d2
C 2192	CHIP CAP.	0.01uF	16V	B	GRM36B103K16PT	K22128804		1-	B	d2
C 2193	CHIP CAP.	0.01uF	16V	B	GRM36B103K16PT	K22128804		1-	B	d1
C 2194	CHIP CAP.	56pF	50V	CH	UMK105CH560JW-F	K22178276		1-	B	d2
C 2195	CHIP CAP.	10pF	50V	CH	UMK105CH100DW-F	K22178258		1-	B	d2
C 2196	CHIP CAP.	33pF	50V	CH	UMK105CH330JW-F	K22178270		1-	B	d2
C 2199	CHIP CAP.	0.01uF	16V	B	GRM36B103K16PT	K22128804		1-	A	D1
C 2200	CHIP CAP.	10pF	50V	CH	UMK105CH100DW-F	K22178258		1-	B	c1
C 2205	CHIP CAP.	0.1uF	10V	B	GRM36B104K10PT	K22108802		1-	A	C2
C 2206	CHIP CAP.	0.1uF	10V	B	GRM36B104K10PT	K22108802		1-	A	C2
C 2207	CHIP TA.CAP.	22uF	4V		TESVSP0G226M-8R	K78060047		1-		
CD2001	CERAMIC DISC				CDBM450C7	H7900930		1-	B	b1
CD2002	CERAMIC DISC				CDBM450C7	H7900930		1-	B	b2
CF2001	CERAMIC FILTER				SFECV10.7MS2-A-TC	H3900514		1-	B	c2
CF2002	CERAMIC FILTER				ALFYM450F=K	H3900531		1-	B	a1
CF2003	CERAMIC FILTER				ALFYM450F=K	H3900531		1-	B	b3
D 2001	DIODE				DAP222-TL	G2070432		1-	B	c2
D 2002	DIODE				1SS400 TE61	G2070634		1-	A	A2
D 2003	DIODE				DA221 TL	G2070178		1-	B	c1

# AF Unit

REF.	DESCRIPTION	VALUE	V/W	TOL.	MFR'S DESIG	VXSTD P/N	VERS.	LOT.	SIDE	LAY ADR.
D 2004	DIODE				DAN222 TL	G2070174		1-	B	c1
D 2005	DIODE				HVC355B(TAPE)	G2070588		1-	A	A2
D 2006	DIODE				1SV325(TPH3)	G2070848		1-	A	A2
D 2007	DIODE				DAN222 TL	G2070174		1-	A	D1
D 2008	DIODE				DAN222 TL	G2070174		1-	A	B2
D 2009	DIODE				DAN222 TL	G2070174		1-	B	d3
D 2010	DIODE				DAN222 TL	G2070174		1-	B	a1
D 2011	DIODE				HN2D01FUTE85R	G2070348		1-	B	c3
D 2012	DIODE				MC2850-T11-1	G2070704		1-	B	b2
D 2013	DIODE				MC2850-T11-1	G2070704		1-	B	b2
D 2014	DIODE				RB751S-40TE61	G2070850		1-	B	a2
D 2015	DIODE				RD6.8UMB2-T1B	G2070438		1-	B	c1
D 2016	DIODE				MC2850-T11-1	G2070704		1-	B	c2
D 2017	DIODE				DA221 TL	G2070178		1-	B	b3
D 2018	DIODE				DA221 TL	G2070178		1-	B	c3
FB2001	CHIP COIL				BLM10A121SPT	L1690843		1-	A	B1
FB2002	CHIP COIL				BLM10A121SPT	L1690843		1-	A	B2
FB2003	CHIP COIL				BLM10A121SPT	L1690843		1-	A	B2
FB2004	CHIP COIL				BLM10A121SPT	L1690843		1-	A	B2
FB2005	CHIP COIL				BLM10A121SPT	L1690843		1-	A	B1
FB2006	CHIP COIL				BLM10A121SPT	L1690843		1-	A	B2
J 2001	CONNECTOR				IL-FHR-F40S-HF-E3000	P1091131		1-	A	B3
J 2002	CONNECTOR				KP-269	P1091150		1-	B	c1
L 2001	M.RFC	0.39uH			LK1608 R39K-T	L1690413		1-	B	c2
L 2002	M.RFC	0.15uH			LK1608 R15K-T	L1690409		1-	B	c2
L 2005	M.RFC	0.47uH			LK1608 R47K-T	L1690414		1-	A	B2
L 2006	M.RFC	1uH			LK1608 1R0K-T	L1690687		1-	A	B2
L 2007	M.RFC	0.22uH			LK1608 R22K-T	L1690410		1-	B	d2
L 2008	M.RFC	0.33uH		2%	C1608CA-R33G	L1691106		1-	B	c1
L 2009	M.RFC	4.7uH			LK1608 4R7K-T	L1690688		1-	A	B2
L 2010	M.RFC	1uH			LK1608 1R0K-T	L1690687		1-	A	A2
L 2011	M.RFC	0.082uH			HK1608 82NJ-T	L1690527		1-	A	B2
L 2012	M.RFC	0.018uH		2%	C1608CA-18NG	L1691035		1-	A	A2
L 2013	M.RFC	4.7uH			LK1608 4R7K-T	L1690688		1-	A	A2
L 2014	M.RFC	0.082uH		2%	C1608CA-82NG	L1691044		1-	A	A1
L 2015	M.RFC	0.1uH			LK1608 R10K-T	L1690407		1-	A	A1
L 2016	M.RFC	0.47uH			LK1608 R47K-T	L1690414		1-	A	B1
L 2017	M.RFC	10uH		2%	KQ1008TE100G	L1691216		1-	A	C1
L 2018	M.RFC	0.33uH			LK1608 R33K-T	L1690412		1-	B	c3
L 2019	M.RFC	0.33uH			LK1608 R33K-T	L1690412		1-	B	c3
L 2020	M.RFC	0.33uH			LK1608 R33K-T	L1690412		1-	B	d2
L 2021	M.RFC	0.22uH			LK1608 R22K-T	L1690410		1-	B	d2
Q 2001	TRANSISTOR				DTC144EE TL	G3070075		1-	B	c2
Q 2002	TRANSISTOR				2SC4915-O(TE85L)	G3349158O		1-	B	c2
Q 2003	TRANSISTOR				2SC4154-T11-1E	G3341548E		1-	A	B2
Q 2004	TRANSISTOR				2SC4915-O(TE85L)	G3349158O		1-	A	B2
Q 2005	TRANSISTOR				DTC144EE TL	G3070075		1-	B	d3
Q 2006	TRANSISTOR				2SC4915-O(TE85L)	G3349158O		1-	B	d2
Q 2007	IC				MB15A01PFV1-G-BND-EF	G1092545		1-	A	A2
Q 2008	TRANSISTOR				DTA144EE TL	G3070074		1-	A	A2
Q 2009	TRANSISTOR				2SA1774 TL R	G3117748R		1-	A	A1
Q 2010	TRANSISTOR				2SC4915-O(TE85L)	G3349158O		1-	B	d2
Q 2011	TRANSISTOR				2SC4915-O(TE85L)	G3349158O		1-	B	c2
Q 2012	TRANSISTOR				2SC4154-T11-1E	G3341548E		1-	A	B2
Q 2013	TRANSISTOR				2SC4915-O(TE85L)	G3349158O		1-	A	B2
Q 2014	TRANSISTOR				2SA1774 TL R	G3117748R		1-	A	A1
Q 2015	TRANSISTOR				DTC144EE TL	G3070075		1-	A	A1
Q 2016	IC				TA31136FN(EL)	G1091605		1-	B	b1
Q 2017	TRANSISTOR				2SC5374-TL	G3353748		1-	A	A2
Q 2018	TRANSISTOR				2SC5374-TL	G3353748		1-	A	A1

REF.	DESCRIPTION	VALUE	V/W	TOL.	MFR'S DESIG	VXSTD P/N	VERS.	LOT.	SIDE	LAY ADR.
Q 2019	TRANSISTOR				2SC5374-TL	G3353748		1-	A	B2
Q 2020	TRANSISTOR				2SA1774 TL R	G3117748R		1-	A	C1
Q 2021	TRANSISTOR				2SA1774 TL R	G3117748R		1-	A	C1
Q 2022	TRANSISTOR				2SC4154-T11-1E	G3341548E		1-	B	b1
Q 2023	TRANSISTOR				2SC4154-T11-1E	G3341548E		1-	B	a2
Q 2024	TRANSISTOR				2SA1774 TL R	G3117748R		1-	B	c3
Q 2025	TRANSISTOR				2SA1774 TL R	G3117748R		1-	B	c3
Q 2026	TRANSISTOR				2SA1774 TL R	G3117748R		1-	B	d3
Q 2027	TRANSISTOR				DTC144EE TL	G3070075		1-	A	C1
Q 2028	TRANSISTOR				DTC144EE TL	G3070075		1-	B	b2
Q 2029	FET				2SJ364-R(TX)	G3703648R		1-	A	C2
Q 2030	TRANSISTOR				2SC4154-T11-1E	G3341548E		1-	B	a2
Q 2031	TRANSISTOR				2SC5374-TL	G3353748		1-	B	c3
Q 2032	TRANSISTOR				2SC4154-T11-1E	G3341548E		1-	B	c1
Q 2033	TRANSISTOR				CPH6102-TL	G3070223		1-	B	c1
Q 2034	TRANSISTOR				DTA144EE TL	G3070074		1-	B	d1
Q 2035	TRANSISTOR				DTC144EE TL	G3070075		1-	B	d1
Q 2036	FET				2SJ364-R(TX)	G3703648R		1-	A	C2
Q 2037	IC				TA31136FN(EL)	G1091605		1-	B	b2
Q 2038	TRANSISTOR				2SC4915-O(TE85L)	G3349158O		1-	B	c2
Q 2039	TRANSISTOR				DTC143ZE TL	G3070102		1-	B	c1
Q 2040	IC				TDA7233D-TR	G1091112		1-	A	B1
Q 2041	TRANSISTOR				2SC4154-T11-1E	G3341548E		1-	A	C2
Q 2042	FET				2SJ364-R(TX)	G3703648R		1-	A	D2
Q 2043	FET				2SJ364-R(TX)	G3703648R		1-	A	C2
Q 2044	TRANSISTOR				2SC4154-T11-1E	G3341548E		1-	B	b3
Q 2045	TRANSISTOR				2SC4154-T11-1E	G3341548E		1-	A	C2
Q 2046	TRANSISTOR				DTC144EE TL	G3070075		1-	A	D2
Q 2047	FET				2SJ364-R(TX)	G3703648R		1-	A	C2
Q 2048	IC				BU4094BCFV-E2	G1093527		1-	A	C3
Q 2049	TRANSISTOR				2SA1774 TL R	G3117748R		1-	B	d3
R 2002	CHIP RES.	470	1/16W	5%	RMC1/16S 471JTH	J24189021		1-	B	c2
R 2003	CHIP RES.	470	1/16W	5%	RMC1/16S 471JTH	J24189021		1-	B	c2
R 2004	CHIP RES.	100k	1/16W	5%	RMC1/16S 104JTH	J24189049		1-	B	c2
R 2005	CHIP RES.	1k	1/16W	5%	RMC1/16S 102JTH	J24189025		1-	A	B2
R 2006	CHIP RES.	10k	1/16W	5%	RMC1/16S 103JTH	J24189037		1-	A	B2
R 2007	CHIP RES.	100k	1/16W	5%	RMC1/16S 104JTH	J24189049		1-	A	A2
R 2008	CHIP RES.	470	1/16W	5%	RMC1/16S 471JTH	J24189021		1-	B	c2
R 2009	CHIP RES.	100k	1/16W	5%	RMC1/16S 104JTH	J24189049		1-	A	B2
R 2010	CHIP RES.	100	1/16W	5%	RMC1/16S 101JTH	J24189013		1-	A	B2
R 2012	CHIP RES.	150k	1/16W	5%	RMC1/16S 154JTH	J24189051		1-	B	d2
R 2013	CHIP RES.	100	1/16W	5%	RMC1/16S 101JTH	J24189013		1-	B	d2
R 2014	CHIP RES.	4.7k	1/16W	5%	RMC1/16S 472JTH	J24189033		1-	A	A2
R 2015	CHIP RES.	1k	1/16W	5%	RMC1/16S 102JTH	J24189025		1-	A	A2
R 2016	CHIP RES.	1k	1/16W	5%	RMC1/16S 102JTH	J24189025		1-	A	A2
R 2017	CHIP RES.	1k	1/16W	5%	RMC1/16S 102JTH	J24189025		1-	A	B2
R 2018	CHIP RES.	10k	1/16W	5%	RMC1/16S 103JTH	J24189037		1-	A	A1
R 2019	CHIP RES.	100	1/16W	5%	RMC1/16S 101JTH	J24189013		1-	B	c2
R 2021	CHIP RES.	470k	1/16W	5%	RMC1/16S 474JTH	J24189057		1-	B	c2
R 2022	CHIP RES.	33k	1/16W	5%	RMC1/16S 333JTH	J24189043		1-	B	c2
R 2023	CHIP RES.	330	1/16W	5%	RMC1/16S 331JTH	J24189019		1-	B	c2
R 2024	CHIP RES.	1k	1/16W	5%	RMC1/16S 102JTH	J24189025		1-	B	d1
R 2025	CHIP RES.	100	1/16W	5%	RMC1/16S 101JTH	J24189013		1-	B	c2
R 2026	CHIP RES.	10k	1/16W	5%	RMC1/16S 103JTH	J24189037		1-	A	B2
R 2028	CHIP RES.	1.5k	1/16W	5%	RMC1/16S 152JTH	J24189027		1-	A	A2
R 2029	CHIP RES.	1.8k	1/16W	5%	RMC1/16S 182JTH	J24189028		1-	A	A2
R 2030	CHIP RES.	3.3k	1/16W	5%	RMC1/16S 332JTH	J24189031		1-	A	A2
R 2031	CHIP RES.	2.2k	1/16W	5%	RMC1/16S 222JTH	J24189029		1-	A	A2
R 2032	CHIP RES.	100k	1/16W	5%	RMC1/16S 104JTH	J24189049		1-	A	B2
R 2033	CHIP RES.	100	1/16W	5%	RMC1/16S 101JTH	J24189013		1-	A	B2

# AF Unit

REF.	DESCRIPTION	VALUE	V/W	TOL.	MFR'S DESIG	VXSTD P/N	VERS.	LOT.	SIDE	LAY ADR.
R 2034	CHIP RES.	4.7k	1/16W	5%	RMC1/16S 472JTH	J24189033		1-	A	A1
R 2035	CHIP RES.	22k	1/16W	5%	RMC1/16S 223JTH	J24189041		1-	A	A1
R 2036	CHIP RES.	10k	1/16W	5%	RMC1/16S 103JTH	J24189037		1-	A	A1
R 2037	CHIP RES.	100k	1/16W	5%	RMC1/16S 104JTH	J24189049		1-	B	b1
R 2038	CHIP RES.	10k	1/16W	5%	RMC1/16S 103JTH	J24189037		1-	A	C1
R 2039	CHIP RES.	1k	1/16W	5%	RMC1/16S 102JTH	J24189025		1-	B	c1
R 2040	CHIP RES.	220	1/16W	5%	RMC1/16S 221JTH	J24189017		1-	A	C2
R 2043	CHIP RES.	22k	1/16W	5%	RMC1/16S 223JTH	J24189041		1-	A	D1
R 2044	CHIP RES.	10k	1/16W	5%	RMC1/16S 103JTH	J24189037		1-	A	D1
R 2045	CHIP RES.	100	1/16W	5%	RMC1/16S 101JTH	J24189013		1-	A	D1
R 2046	CHIP RES.	10k	1/16W	5%	RMC1/16S 103JTH	J24189037		1-	A	D1
R 2047	CHIP RES.	2.7k	1/16W	5%	RMC1/16S 272JTH	J24189030		1-	A	A1
R 2048	CHIP RES.	100	1/16W	5%	RMC1/16S 101JTH	J24189013		1-	A	A1
R 2049	CHIP RES.	100	1/16W	5%	RMC1/16S 101JTH	J24189013		1-	A	A1
R 2050	CHIP RES.	3.3k	1/16W	5%	RMC1/16S 332JTH	J24189031		1-	A	A1
R 2051	CHIP RES.	47	1/16W	5%	RMC1/16S 470JTH	J24189009		1-	A	A2
R 2052	CHIP RES.	150	1/16W	5%	RMC1/16S 151JTH	J24189015		1-	A	A1
R 2053	CHIP RES.	100	1/16W	5%	RMC1/16S 101JTH	J24189013		1-	A	A1
R 2054	CHIP RES.	100	1/16W	5%	RMC1/16S 101JTH	J24189013		1-	A	A1
R 2055	CHIP RES.	10k	1/16W	5%	RMC1/16S 103JTH	J24189037		1-	A	B2
R 2056	CHIP RES.	1.5k	1/16W	5%	RMC1/16S 152JTH	J24189027		1-	A	C1
R 2057	CHIP RES.	220	1/16W	5%	RMC1/16S 221JTH	J24189017		1-	A	C1
R 2058	CHIP RES.	10k	1/16W	5%	RMC1/16S 103JTH	J24189037		1-	A	C1
R 2059	CHIP RES.	330k	1/16W	5%	RMC1/16S 334JTH	J24189055		1-	B	b1
R 2060	CHIP RES.	10k	1/16W	5%	RMC1/16S 103JTH	J24189037		1-	B	b1
R 2061	CHIP RES.	4.7k	1/16W	5%	RMC1/16S 472JTH	J24189033		1-	B	b1
R 2062	CHIP RES.	3.3k	1/16W	5%	RMC1/16S 332JTH	J24189031		1-	B	b1
R 2063	CHIP RES.	15k	1/16W	5%	RMC1/16S 153JTH	J24189039		1-	B	b1
R 2064	CHIP RES.	330k	1/16W	5%	RMC1/16S 334JTH	J24189055		1-	B	b2
R 2065	CHIP RES.	100	1/16W	5%	RMC1/16S 101JTH	J24189013		1-	A	C1
R 2066	CHIP RES.	10k	1/16W	5%	RMC1/16S 103JTH	J24189037		1-	A	D1
R 2067	CHIP RES.	680	1/16W	5%	RMC1/16S 681JTH	J24189023		1-	B	b1
R 2068	CHIP RES.	0	1/16W	5%	RMC1/16S JPTH	J24189070		1-	B	a1
R 2069	CHIP RES.	3.3k	1/16W	5%	RMC1/16S 332JTH	J24189031		1-	B	b1
R 2070	CHIP RES.	560k	1/16W	5%	RMC1/16S 564JTH	J24189058		1-	B	a2
R 2071	CHIP RES.	10k	1/16W	5%	RMC1/16S 103JTH	J24189037		1-	B	a1
R 2072	CHIP RES.	470	1/16W	5%	RMC1/16S 471JTH	J24189021		1-	B	a1
R 2073	CHIP RES.	10k	1/16W	5%	RMC1/16S 103JTH	J24189037		1-	B	c3
R 2074	CHIP RES.	10k	1/16W	5%	RMC1/16S 103JTH	J24189037		1-	B	c3
R 2075	CHIP RES.	10k	1/16W	5%	RMC1/16S 103JTH	J24189037		1-	B	d3
R 2076	CHIP RES.	330k	1/16W	5%	RMC1/16S 334JTH	J24189055		1-	A	C2
R 2077	CHIP RES.	10k	1/16W	5%	RMC1/16S 103JTH	J24189037		1-	A	C2
R 2078	CHIP RES.	330k	1/16W	5%	RMC1/16S 334JTH	J24189055		1-	A	C2
R 2079	CHIP RES.	4.7k	1/16W	5%	RMC1/16S 472JTH	J24189033		1-	B	a2
R 2080	CHIP RES.	3.3k	1/16W	5%	RMC1/16S 332JTH	J24189031		1-	B	b2
R 2081	CHIP RES.	1k	1/16W	5%	RMC1/16S 102JTH	J24189025		1-	B	b2
R 2082	CHIP RES.	220k	1/16W	5%	RMC1/16S 224JTH	J24189053		1-	B	a2
R 2083	CHIP RES.	4.7k	1/16W	5%	RMC1/16S 472JTH	J24189033		1-	B	a2
R 2084	CHIP RES.	1M	1/16W	5%	RMC1/16S 105JTH	J24189061		1-	B	b2
R 2085	CHIP RES.	100k	1/16W	5%	RMC1/16S 104JTH	J24189049		1-	B	b2
R 2086	CHIP RES.	1k	1/16W	5%	RMC1/16S 102JTH	J24189025		1-	B	b2
R 2087	CHIP RES.	1k	1/16W	5%	RMC1/16S 102JTH	J24189025		1-	B	c3
R 2088	CHIP RES.	100	1/16W	5%	RMC1/16S 101JTH	J24189013		1-	B	a2
R 2089	CHIP RES.	220k	1/16W	5%	RMC1/16S 224JTH	J24189053		1-	B	c3
R 2090	CHIP RES.	100k	1/16W	5%	RMC1/16S 104JTH	J24189049		1-	B	a2
R 2091	CHIP RES.	56k	1/16W	5%	RMC1/16S 563JTH	J24189046		1-	B	a2
R 2093	CHIP RES.	470	1/16W	5%	RMC1/16S 471JTH	J24189021		1-	B	c3
R 2094	CHIP RES.	10k	1/16W	5%	RMC1/16S 103JTH	J24189037		1-	B	c1
R 2095	CHIP RES.	1k	1/16W	5%	RMC1/16S 102JTH	J24189025		1-	B	c1
R 2096	CHIP RES.	10k	1/16W	5%	RMC1/16S 103JTH	J24189037		1-	A	C2

REF.	DESCRIPTION	VALUE	V/W	TOL.	MFR'S DESIG	VXSTD P/N	VERS.	LOT.	SIDE	LAY ADR.
R 2097	CHIP RES.	330k	1/16W	5%	RMC1/16S 334JTH	J24189055		1-	A	C2
R 2098	CHIP RES.	100k	1/16W	5%	RMC1/16S 104JTH	J24189049		1-	B	c2
R 2099	CHIP RES.	220	1/16W	5%	RMC1/16S 221JTH	J24189017		1-	B	c2
R 2100	CHIP RES.	330k	1/16W	5%	RMC1/16S 334JTH	J24189055		1-	B	c2
R 2101	CHIP RES.	22k	1/16W	5%	RMC1/16S 223JTH	J24189041		1-	A	B1
R 2102	CHIP RES.	470k	1/16W	5%	RMC1/16S 474JTH	J24189057		1-	A	C2
R 2103	CHIP RES.	2.7k	1/16W	5%	RMC1/16S 272JTH	J24189030		1-	A	C2
R 2104	CHIP RES.	47	1/16W	5%	RMC1/16S 470JTH	J24189009		1-	A	C2
R 2105	CHIP RES.	10k	1/16W	5%	RMC1/16S 103JTH	J24189037		1-	A	C2
R 2106	CHIP RES.	33k	1/16W	5%	RMC1/16S 333JTH	J24189043		1-	A	C2
R 2107	CHIP RES.	330k	1/16W	5%	RMC1/16S 334JTH	J24189055		1-	A	D2
R 2108	CHIP RES.	330k	1/16W	5%	RMC1/16S 334JTH	J24189055		1-	A	C2
R 2109	CHIP RES.	1.5k	1/16W	5%	RMC1/16S 152JTH	J24189027		1-	A	C2
R 2110	CHIP RES.	4.7k	1/16W	5%	RMC1/16S 472JTH	J24189033		1-	B	c2
R 2111	CHIP RES.	10k	1/16W	5%	RMC1/16S 103JTH	J24189037		1-	B	c2
R 2112	CHIP RES.	15k	1/16W	5%	RMC1/16S 153JTH	J24189039		1-	B	c2
R 2113	CHIP RES.	100	1/16W	5%	RMC1/16S 101JTH	J24189013		1-	B	c3
R 2114	CHIP RES.	330k	1/16W	5%	RMC1/16S 334JTH	J24189055		1-	B	b2
R 2115	CHIP RES.	680	1/16W	5%	RMC1/16S 681JTH	J24189023		1-	B	c3
R 2116	CHIP RES.	3.3k	1/16W	5%	RMC1/16S 332JTH	J24189031		1-	B	c2
R 2117	CHIP RES.	330k	1/16W	5%	RMC1/16S 334JTH	J24189055		1-	B	b3
R 2118	CHIP RES.	3.3k	1/16W	5%	RMC1/16S 332JTH	J24189031		1-	B	b3
R 2119	CHIP RES.	3.3k	1/16W	5%	RMC1/16S 332JTH	J24189031		1-	B	b3
R 2120	CHIP RES.	1k	1/16W	5%	RMC1/16S 102JTH	J24189025		1-	B	c3
R 2121	CHIP RES.	10k	1/16W	5%	RMC1/16S 103JTH	J24189037		1-	A	B1
R 2122	CHIP RES.	10	1/16W	5%	RMC1/16S 100JTH	J24189001		1-	A	B1
R 2123	CHIP RES.	150k	1/16W	5%	RMC1/16S 154JTH	J24189051		1-	A	C2
R 2124	CHIP RES.	2.2M	1/16W	5%	RMC1/16S 225JTH	J24189065		1-	A	C2
R 2125	CHIP RES.	2.2k	1/16W	5%	RMC1/16S 222JTH	J24189029		1-	A	C2
R 2126	CHIP RES.	10k	1/16W	5%	RMC1/16S 103JTH	J24189037		1-	A	C2
R 2127	CHIP RES.	4.7k	1/16W	5%	RMC1/16S 472JTH	J24189033		1-	A	D2
R 2128	CHIP RES.	10k	1/16W	5%	RMC1/16S 103JTH	J24189037		1-	A	D2
R 2129	CHIP RES.	10k	1/16W	5%	RMC1/16S 103JTH	J24189037		1-	A	D2
R 2130	CHIP RES.	100k	1/16W	5%	RMC1/16S 104JTH	J24189049		1-	A	D2
R 2131	CHIP RES.	330k	1/16W	5%	RMC1/16S 334JTH	J24189055		1-	A	D2
R 2132	CHIP RES.	330k	1/16W	5%	RMC1/16S 334JTH	J24189055		1-	A	C2
R 2133	CHIP RES.	10k	1/16W	5%	RMC1/16S 103JTH	J24189037		1-	A	C2
R 2134	CHIP RES.	10k	1/16W	5%	RMC1/16S 103JTH	J24189037		1-	A	D3
R 2135	CHIP RES.	1M	1/16W	5%	RMC1/16S 105JTH	J24189061		1-	B	b3
R 2136	CHIP RES.	100k	1/16W	5%	RMC1/16S 104JTH	J24189049		1-	B	b3
R 2137	CHIP RES.	1k	1/16W	5%	RMC1/16S 102JTH	J24189025		1-	A	C3
R 2138	CHIP RES.	1k	1/16W	5%	RMC1/16S 102JTH	J24189025		1-	A	C3
R 2139	CHIP RES.	1k	1/16W	5%	RMC1/16S 102JTH	J24189025		1-	A	C2
R 2140	CHIP RES.	100	1/16W	5%	RMC1/16S 101JTH	J24189013		1-	B	d2
R 2142	CHIP RES.	1k	1/16W	5%	RMC1/16S 102JTH	J24189025		1-	A	B2
R 2143	CHIP RES.	4.7k	1/16W	5%	RMC1/16S 472JTH	J24189033		1-	B	d3
R 2144	CHIP RES.	1k	1/16W	5%	RMC1/16S 102JTH	J24189025		1-	B	c1
R 2145	CHIP RES.	10k	1/16W	5%	RMC1/16S 103JTH	J24189037		1-	A	C2
R 2146	CHIP RES.	10k	1/16W	5%	RMC1/16S 103JTH	J24189037		1-	A	D2
R 2147	CHIP RES.	10k	1/16W	5%	RMC1/16S 103JTH	J24189037		1-		
S 2001	TACT SWITCH				SKQTLA	N5090110		1-	B	d3
S 2002	TACT SWITCH				SKQTLA	N5090110		1-	B	d2
S 2003	ROTARY ENCODER				TP70D270E20 20F A203	Q9000789A		1-	B	a1
XF2001	XTAL FILTER	47.25MHz			MF47R2 47.25MHZ	H1102347		1-	B	c2
XF2002	XTAL FILTER	46.35MHz			MF46R5 46.35MHZ	H1102348		1-	B	c2
	SHIELD PLATE				(AF)	RA0406800		1-		

***AF Unit***  
***Note:***





# CNTL Unit

## Parts Layout

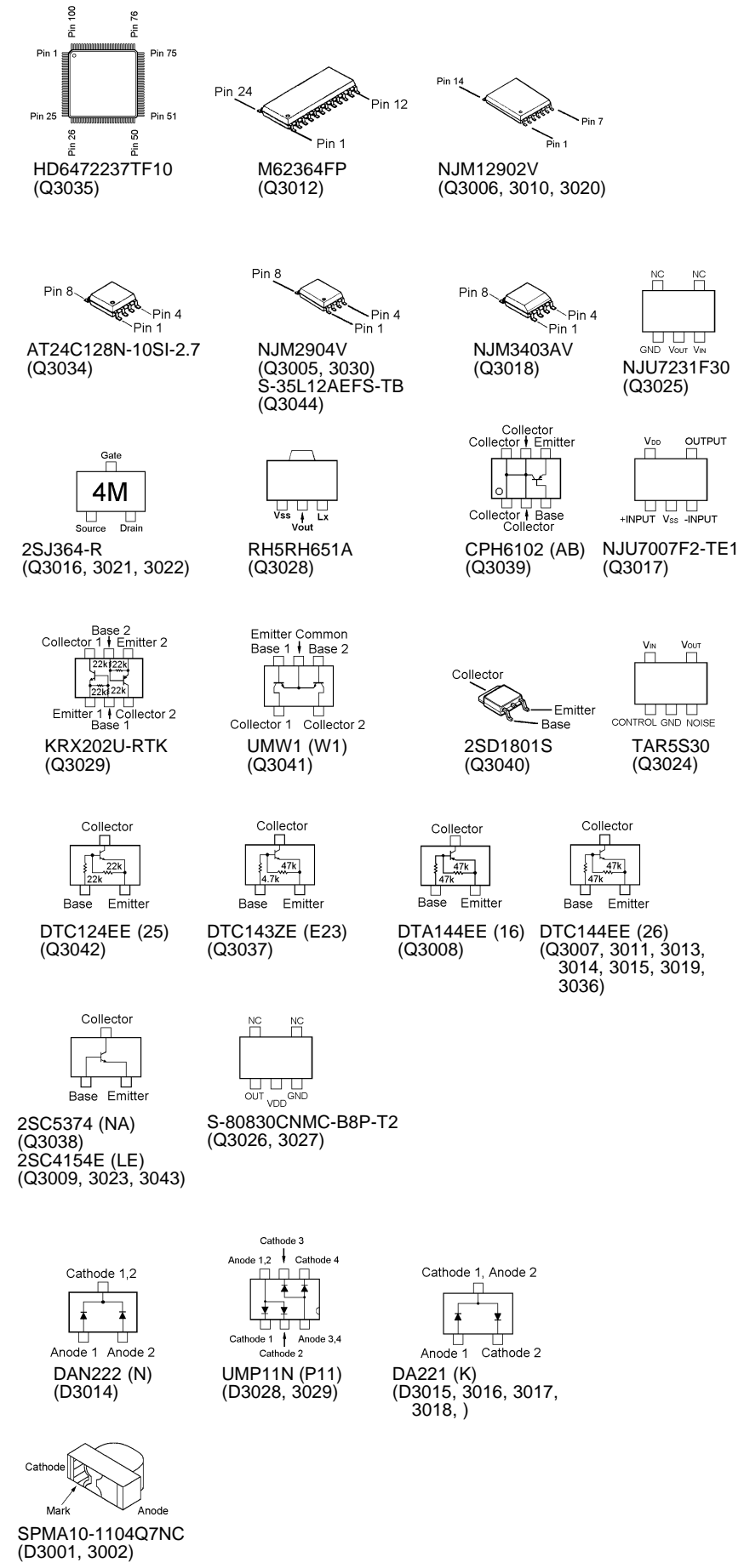
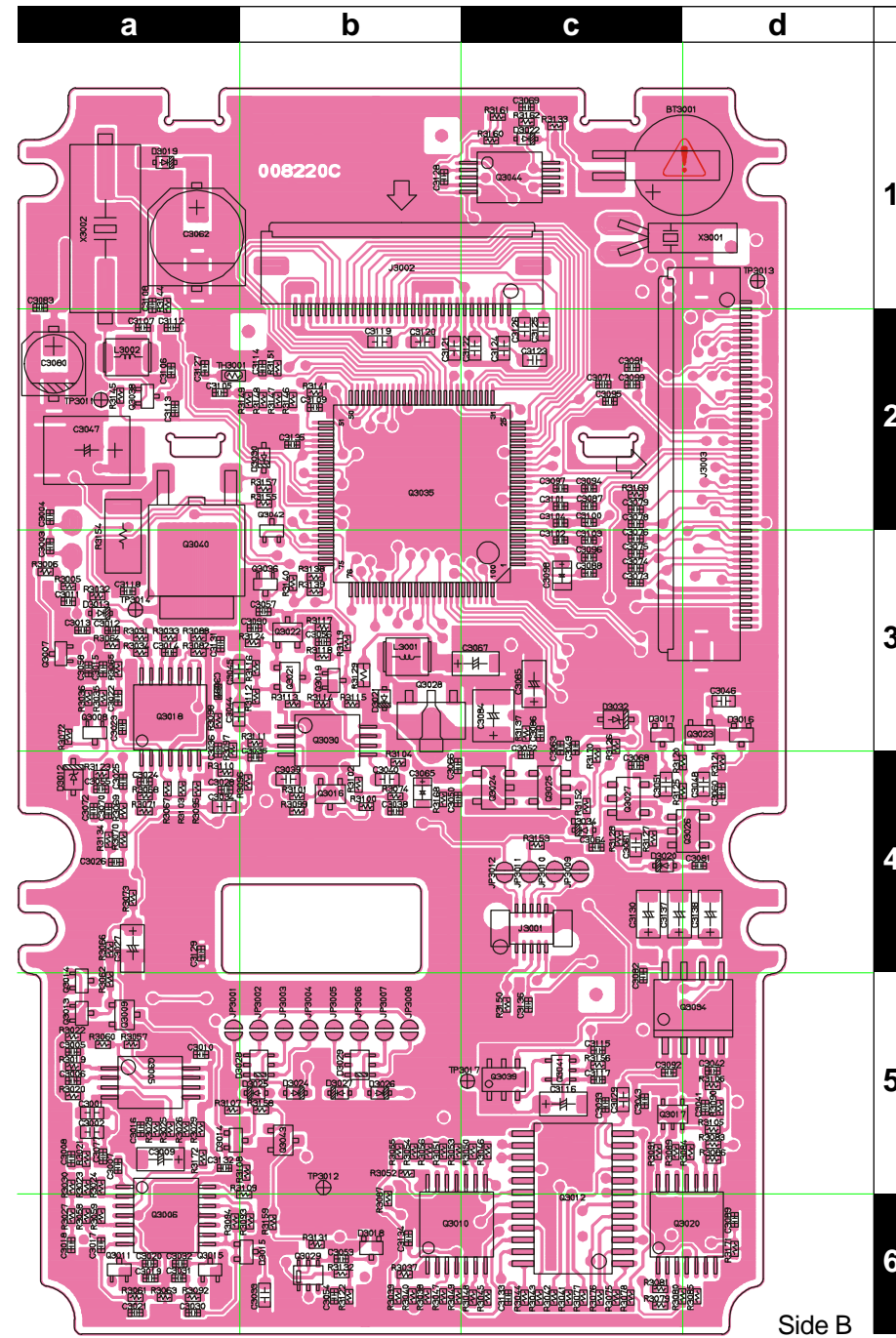
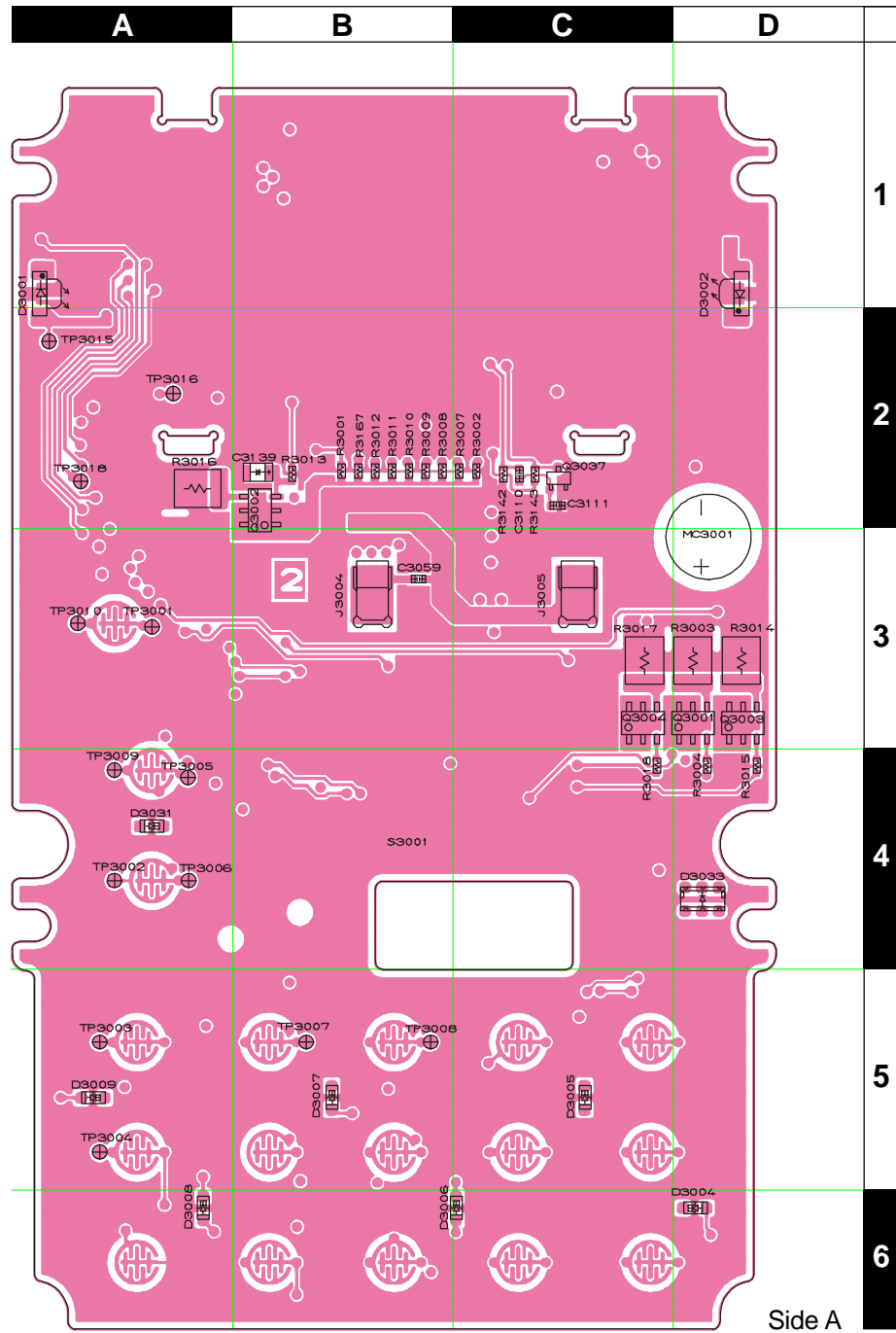

**⚠ CAUTION**  
 Danger of explosion if battery BT3001 is in correctly replaced. Replace only with the Same of equivalent Type.



## Parts List

REF.	DESCRIPTION	VALUE	V/W	TOL.	MFR'S DESIG	VXSTD P/N	VERS.	LOT.	SIDE	LAY ADR.
	PCB with Components					CB1871002	USA			
	PCB with Components					CB1871003	VERSION A1			
	PCB with Components					CB1871004	VERSION A2			
	PCB with Components					CB1871005	VERSION A3			
	PCB with Components					CB1871006	VERSION B1			
	PCB with Components					CB1871007	VERSION B2			
	PCB with Components					CB1871008	VERSION B3			
	PCB with Components					CB1871009	VERSION C1			
	PCB with Components					CB1871010	VERSION C2			
	PCB with Components					CB1871011	VERSION C2			
	PCB with Components					CB1871012	VERSION D1			
	PCB with Components					CB1871013	VERSION D2			
	PCB with Components					CB1871014	TYP:B1 GERMANY			
	PCB with Components					CB1871015	TYP:B2 GERMANY			
Printed Circuit Board						FR008220C		1-		
BT3001	LI-ION BATTERY				MS614-FL28N	Q9000783		1-	B	c1
C 3001	CHIP CAP.	1uF	10V	F	GRM39F105Z10PT	K22105001		1-	B	a5
C 3002	CHIP CAP.	1uF	10V	F	GRM39F105Z10PT	K22105001		1-	B	a5
C 3003	CHIP CAP.	0.001uF	50V	B	UMK105B102KW-F	K22178829		1-	B	a3
C 3004	CHIP CAP.	0.001uF	50V	B	UMK105B102KW-F	K22178829		1-	B	a2
C 3005	CHIP CAP.	0.0047uF	25V	B	TMK105B472KW-F	K22148831		1-	B	a5
C 3006	CHIP CAP.	0.0047uF	25V	B	TMK105B472KW-F	K22148831		1-	B	a5
C 3007	CHIP CAP.	0.0027uF	50V	B	UMK105B272KW-F	K22178834		1-	B	a5
C 3008	CHIP CAP.	0.01uF	16V	B	GRM36B103K16PT	K22128804		1-	B	a5
C 3009	CHIP TA.CAP.	22uF	4V		TEMSVA0G226M-8R	K78060023		1-	B	a5
C 3011	CHIP CAP.	0.001uF	50V	B	UMK105B102KW-F	K22178829		1-	B	a3
C 3012	CHIP CAP.	0.0047uF	25V	B	TMK105B472KW-F	K22148831		1-	B	a3
C 3013	CHIP CAP.	0.001uF	50V	B	UMK105B102KW-F	K22178829		1-	B	a3
C 3014	CHIP CAP.	0.001uF	50V	B	UMK105B102KW-F	K22178829		1-	B	a3
C 3015	CHIP CAP.	0.001uF	50V	B	UMK105B102KW-F	K22178829		1-	B	a3
C 3016	CHIP CAP.	0.001uF	50V	B	UMK105B102KW-F	K22178829		1-	B	a5
C 3017	CHIP CAP.	0.015uF	50V	F	UMK105F153ZW-F	K22179018		1-	B	a6
C 3018	CHIP CAP.	0.022uF	16V	B	GRM36B223K16PT	K22128806		1-	B	a6
C 3019	CHIP CAP.	270pF	50V	B	UMK105B271KW-F	K22178822		1-	B	a6
C 3020	CHIP CAP.	0.001uF	50V	B	UMK105B102KW-F	K22178829		1-	B	a6
C 3021	CHIP CAP.	0.022uF	16V	B	GRM36B223K16PT	K22128806		1-	B	a6
C 3022	CHIP CAP.	0.047uF	10V	B	GRM36B473K10PT	K22108801		1-	B	a3
C 3023	CHIP CAP.	0.001uF	50V	B	UMK105B102KW-F	K22178829		1-	B	a3
C 3024	CHIP CAP.	180pF	25V	CH	TMK105CH181JW-F	K22148244		1-	B	a4
C 3025	CHIP CAP.	0.01uF	16V	B	GRM36B103K16PT	K22128804		1-	B	a4
C 3026	CHIP CAP.	0.01uF	16V	B	GRM36B103K16PT	K22128804		1-	B	a4
C 3027	CHIP TA.CAP.	22uF	4V		TEMSVA0G226M-8R	K78060023		1-	B	a4
C 3028	CHIP CAP.	0.001uF	50V	B	UMK105B102KW-F	K22178829		1-	B	a4
C 3029	CHIP CAP.	1uF	10V	F	GRM39F105Z10PT	K22105001		1-	B	c5
C 3030	CHIP CAP.	0.015uF	50V	F	UMK105F153ZW-F	K22179018		1-	B	a6
C 3031	CHIP CAP.	270pF	50V	B	UMK105B271KW-F	K22178822		1-	B	a6
C 3032	CHIP CAP.	0.001uF	50V	B	UMK105B102KW-F	K22178829		1-	B	a6
C 3033	CHIP CAP.	0.047uF	16V	B	GRM39B473K16PT	K22124804		1-	B	b6
C 3034	CHIP CAP.	1uF	10V	F	GRM39F105Z10PT	K22105001		1-	B	a4
C 3035	CHIP CAP.	0.0033uF	50V	B	GRM36B332K50PT	K22178815		1-	B	a4
C 3036	CHIP CAP.	0.01uF	16V	B	GRM36B103K16PT	K22128804		1-	B	a3
C 3037	CHIP CAP.	0.0022uF	50V	B	UMK105B222KW-F	K22178833		1-	B	a3
C 3038	CHIP CAP.	0.001uF	50V	B	UMK105B102KW-F	K22178829		1-	B	b4
C 3039	CHIP CAP.	1uF	10V	F	GRM39F105Z10PT	K22105001		1-	B	b4
C 3040	CHIP CAP.	1uF	10V	F	GRM39F105Z10PT	K22105001		1-	B	b4
C 3041	CHIP CAP.	0.01uF	16V	B	GRM36B103K16PT	K22128804		1-	B	d5
C 3042	CHIP CAP.	0.001uF	50V	B	UMK105B102KW-F	K22178829		1-	B	d5
C 3043	CHIP CAP.	0.001uF	50V	B	UMK105B102KW-F	K22178829		1-	B	c5
C 3044	CHIP CAP.	1uF	10V	F	GRM39F105Z10PT	K22105001		1-	B	a3
C 3045	CHIP CAP.	1uF	10V	F	GRM39F105Z10PT	K22105001		1-	B	a3

# CNTL Unit

REF.	DESCRIPTION	VALUE	V/W	TOL.	MFR'S DESIG	VXSTD P/N	VERS.	LOT.	SIDE	LAY ADR.
C 3046	CHIP CAP.	1uF	10V	F	GRM39F105Z10PT	K22105001		1-	B	d3
C 3047	CHIP TA.CAP.	220uF	4V		SK4-0G227M-RD	K78060014		1-	B	a2
C 3048	CHIP CAP.	1uF	10V	F	GRM39F105Z10PT	K22105001		1-	B	d4
C 3049	CHIP CAP.	0.001uF	50V	B	UMK105B102KW-F	K22178829		1-	B	c3
C 3050	CHIP CAP.	0.01uF	16V	B	GRM36B103K16PT	K22128804		1-	B	b4
C 3051	CHIP CAP.	1uF	10V	F	GRM39F105Z10PT	K22105001		1-	B	c4
C 3052	CHIP CAP.	0.01uF	16V	B	GRM36B103K16PT	K22128804		1-	B	c4
C 3053	CHIP CAP.	100pF	50V	CH	GRM36CH101J50PT	K22178236		1-	B	b6
C 3054	CHIP CAP.	100pF	50V	CH	GRM36CH101J50PT	K22178236		1-	B	b6
C 3055	CHIP CAP.	0.01uF	16V	B	GRM36B103K16PT	K22128804		1-	B	a4
C 3056	CHIP CAP.	0.01uF	16V	B	GRM36B103K16PT	K22128804		1-	B	b3
C 3057	CHIP CAP.	0.01uF	16V	B	GRM36B103K16PT	K22128804		1-	B	b3
C 3060	CHIP CAP.	0.001uF	50V	B	UMK105B102KW-F	K22178829		1-	B	d4
C 3061	CHIP CAP.	1uF	10V	F	GRM39F105Z10PT	K22105001		1-	B	c4
C 3062	AL.ELECTRO.CAP.	47uF	16V		RV4-16V470MF46-RR2	K48120019		1-	B	a1
C 3063	CHIP CAP.	0.01uF	16V	B	GRM36B103K16PT	K22128804		1-	B	c3
C 3064	CHIP CAP.	0.001uF	50V	B	UMK105B102KW-F	K22178829		1-	B	c4
C 3065	CHIP TA.CAP.	10uF	6.3V		TESVSP0J106M-8R	K78080055		1-	B	b4
C 3066	CHIP CAP.	0.001uF	50V	B	UMK105B102KW-F	K22178829		1-	B	b4
C 3067	CHIP TA.CAP.	22uF	4V		TEMSVA0G226M-8R	K78060023		1-	B	b3
C 3068	CHIP CAP.	0.001uF	50V	B	UMK105B102KW-F	K22178829		1-	B	c4
C 3069	CHIP CAP.	0.01uF	16V	B	GRM36B103K16PT	K22128804		1-	B	c1
C 3070	CHIP CAP.	0.01uF	16V	B	GRM36B103K16PT	K22128804		1-	B	a4
C 3080	AL.ELECTRO.CAP.	10uF	16V		RV4-16V100MD46-RR2	K48120018		1-	B	a2
C 3081	CHIP CAP.	0.001uF	50V	B	UMK105B102KW-F	K22178829		1-	B	d4
C 3082	CHIP CAP.	0.001uF	50V	B	UMK105B102KW-F	K22178829		1-	B	c5
C 3084	CHIP TA.CAP.	33uF	10V		TEMSVB21A336M-8R	K78100047		1-	B	c3
C 3085	CHIP TA.CAP.	10uF	10V		TEMSVA1A106M-8R	K78100028		1-	B	c3
C 3086	CHIP CAP.	0.001uF	50V	B	UMK105B102KW-F	K22178829		1-	B	c3
C 3087	CHIP CAP.	0.001uF	50V	B	UMK105B102KW-F	K22178829		1-	B	c2
C 3089	CHIP CAP.	0.01uF	16V	B	GRM36B103K16PT	K22128804		1-	B	d6
C 3090	CHIP CAP.	0.001uF	50V	B	UMK105B102KW-F	K22178829		1-	B	a3
C 3092	CHIP CAP.	0.001uF	50V	B	UMK105B102KW-F	K22178829		1-	B	c5
C 3094	CHIP CAP.	100pF	50V	CH	UMK105CH101JW-F	K22178282		1-	B	c2
C 3095	CHIP CAP.	100pF	50V	CH	UMK105CH101JW-F	K22178282		1-	B	c2
C 3097	CHIP CAP.	100pF	50V	CH	UMK105CH101JW-F	K22178282		1-	B	c2
C 3098	CHIP TA.CAP.	22uF	4V		TESVSP0G226M-8R	K78060047		1-	B	c3
C 3100	CHIP CAP.	0.001uF	50V	B	UMK105B102KW-F	K22178829		1-	B	c2
C 3101	CHIP CAP.	0.001uF	50V	B	UMK105B102KW-F	K22178829		1-	B	c2
C 3105	CHIP CAP.	0.001uF	50V	B	UMK105B102KW-F	K22178829		1-	B	a2
C 3106	CHIP CAP.	15pF	50V	CH	GRM36CH150J50PT	K22178216		1-	B	a2
C 3107	CHIP CAP.	5pF	50V	CH	UMK105CH050CW-F	K22178253		1-	B	a2
C 3108	CHIP CAP.	2pF	50V	CK	UMK105CK020CW-F	K22178250		1-	B	a1
C 3109	CHIP CAP.	0.047uF	10V	B	GRM36B473K10PT	K22108801		1-	B	b2
C 3110	CHIP CAP.	0.1uF	10V	B	GRM36B104K10PT	K22108802		1-	A	C2
C 3111	CHIP CAP.	100pF	50V	CH	GRM36CH101J50PT	K22178236		1-	A	C2
C 3112	CHIP CAP.	15pF	50V	CH	GRM36CH150J50PT	K22178216		1-	B	a2
C 3113	CHIP CAP.	0.01uF	16V	B	GRM36B103K16PT	K22128804		1-	B	a2
C 3114	CHIP CAP.	0.047uF	10V	B	GRM36B473K10PT	K22108801		1-	B	b2
C 3115	CHIP CAP.	0.001uF	50V	B	UMK105B102KW-F	K22178829		1-	B	c5
C 3116	CHIP TA.CAP.	22uF	4V		TEMSVA0G226M-8R	K78060023		1-	B	c5
C 3117	CHIP CAP.	0.001uF	50V	B	UMK105B102KW-F	K22178829		1-	B	c5
C 3118	CHIP CAP.	0.001uF	50V	B	UMK105B102KW-F	K22178829		1-	B	a3
C 3119	CHIP CAP.	1uF	10V	F	GRM39F105Z10PT	K22105001		1-	B	b2
C 3120	CHIP CAP.	1uF	10V	F	GRM39F105Z10PT	K22105001		1-	B	b2
C 3121	CHIP CAP.	1uF	10V	F	GRM39F105Z10PT	K22105001		1-	B	b2
C 3122	CHIP CAP.	1uF	10V	F	GRM39F105Z10PT	K22105001		1-	B	b2
C 3123	CHIP CAP.	1uF	10V	F	GRM39F105Z10PT	K22105001		1-	B	c2
C 3124	CHIP CAP.	1uF	10V	F	GRM39F105Z10PT	K22105001		1-	B	c2
C 3125	CHIP CAP.	1uF	10V	F	GRM39F105Z10PT	K22105001		1-	B	c2

REF.	DESCRIPTION	VALUE	V/W	TOL.	MFR'S DESIG	VXSTD P/N	VERS.	LOT.	SIDE	LAY ADR.
C 3126	CHIP CAP.	1uF	10V	F	GRM39F105Z10PT	K22105001		1-	B	c2
C 3127	CHIP CAP.	0.001uF	50V	B	UMK105B102KW-F	K22178829		1-	B	a2
C 3129	CHIP CAP.	0.001uF	50V	B	UMK105B102KW-F	K22178829		1-	B	a4
C 3130	CHIP TA.CAP.	33uF	4V		TEMSVA0G336M-8R	K78060036		1-	B	c4
C 3131	CHIP CAP.	0.01uF	16V	B	GRM36B103K16PT	K22128804		1-	B	a3
C 3133	CHIP CAP.	0.001uF	50V	B	UMK105B102KW-F	K22178829		1-	B	c6
C 3134	CHIP CAP.	0.001uF	50V	B	UMK105B102KW-F	K22178829		1-	B	b6
C 3136	CHIP CAP.	0.001uF	50V	B	UMK105B102KW-F	K22178829		1-	B	c5
C 3137	CHIP TA.CAP.	33uF	4V		TEMSVA0G336M-8R	K78060036		1-	B	c4
C 3138	CHIP TA.CAP.	33uF	4V		TEMSVA0G336M-8R	K78060036		1-	B	d4
C 3139	CHIP TA.CAP.	22uF	4V		TESVSP0G226M-8R	K78060047		1-	A	B2
C 3140	CHIP TA.CAP.	4.7uF	6.3V		TESVSP0J475M-8R	K78080053		1-		
C 3141	CHIP CAP.	0.001uF	50V	B	UMK105B102KW-F	K22178829		1-		
C 3142	CHIP CAP.	0.001uF	50V	B	UMK105B102KW-F	K22178829		1-		
D 3001	LED				SPMA10-1104Q7NC	G2070878		1-	A	A1
D 3002	LED				SPMA10-1104Q7NC	G2070878		1-	A	D1
D 3004	LED				19-215UYOC/S530-A2/TR8	G2070884		1-	A	D6
D 3005	LED				19-215UYOC/S530-A2/TR8	G2070884		1-	A	C5
D 3006	LED				19-215UYOC/S530-A2/TR8	G2070884		1-	A	C6
D 3007	LED				19-215UYOC/S530-A2/TR8	G2070884		1-	A	B5
D 3008	LED				19-215UYOC/S530-A2/TR8	G2070884		1-	A	A6
D 3009	LED				19-215UYOC/S530-A2/TR8	G2070884		1-	A	A5
D 3012	DIODE				UDZ TE-17 5.1B	G2070448		1-	B	a4
D 3013	DIODE				1SS400 TE61	G2070634		1-	B	a3
D 3014	DIODE				DAN222 TL	G2070174		1-	B	a5
D 3015	DIODE				DA221 TL	G2070178		1-	B	a6
D 3016	DIODE				DA221 TL	G2070178		1-	B	d3
D 3017	DIODE				DA221 TL	G2070178		1-	B	c3
D 3018	DIODE				DA221 TL	G2070178		1-	B	b6
D 3019	DIODE				RB521S-30 TE61	G2070642		1-	B	a1
D 3020	DIODE				RB751S-40TE61	G2070850		1-	B	c4
D 3021	DIODE				RB751S-40TE61	G2070850		1-	B	b3
D 3022	DIODE				RB751S-40TE61	G2070850		1-	B	c1
D 3024	DIODE				1SS400 TE61	G2070634		1-	B	b5
D 3025	DIODE				1SS400 TE61	G2070634		1-	B	b5
D 3026	DIODE				1SS400 TE61	G2070634		1-	B	b5
D 3027	DIODE				1SS400 TE61	G2070634		1-	B	b5
D 3028	DIODE				UMP11N TN	G2070646		1-	B	b5
D 3029	DIODE				UMP11N TN	G2070646		1-	B	b5
D 3030	DIODE				RD2.0UM-T2	G2070190		1-	B	b2
D 3031	LED				19-215UYOC/S530-A2/TR8	G2070884		1-	A	A4
D 3032	DIODE				UDZS TE-17 9.1B	G2070868		1-	B	c3
D 3033	LED				FRGB1312CE-10-TF	G2070870		1-	A	D4
D 3034	DIODE				1SS400 TE61	G2070634		1-	B	c4
D 3035	DIODE				RB551V-30 TE-17	G2070892		1-		
DS3001	LCD MODULE				LM7910FWTU	Q7000426		1-		
J 3001	CONNECTOR				AXK6F10335P	P0091225		1-	B	c4
J 3002	CONNECTOR				IL-FHR-F30S-HF-E3000	P1091027		1-	B	b1
J 3003	CONNECTOR				IL-FHR-F45S-HF-E3000	P1091135		1-	B	d2
J 3004	SHIELD FINGER				2026 3100012	S5000196		1-	A	B3
J 3005	SHIELD FINGER				2026 3100012	S5000196		1-	A	C3
L 3001	M.RFC	150uH			FLC32P-T-151K	L1690661		1-	B	b3
L 3002	M.RFC	150uH			FLC32T-151J	L1690229		1-	B	a2
MC3001	MIC. ELEMENT				EM-140	M3290032		1-	A	D3
Q 3001	TRANSISTOR				CPH6202-TL	G3070265		1-	A	D3
Q 3002	TRANSISTOR				CPH6202-TL	G3070265		1-	A	B2
Q 3003	TRANSISTOR				CPH6202-TL	G3070265		1-	A	D3
Q 3004	TRANSISTOR				CPH6202-TL	G3070265		1-	A	C3
Q 3005	IC				NJM2904V-TE1	G1091677		1-	B	a5
Q 3006	IC				NJM12902V(Te1)	G1093592		1-	B	a6

# CNTL Unit

REF.	DESCRIPTION	VALUE	V/W	TOL.	MFR'S DESIG	VXSTD P/N	VERS.	LOT.	SIDE	LAY ADR.
Q 3007	TRANSISTOR				DTC144EE TL	G3070075		1-	B	a3
Q 3008	TRANSISTOR				DTA144EE TL	G3070074		1-	B	a3
Q 3009	TRANSISTOR				2SC4154-T11-1E	G3341548E		1-	B	a5
Q 3010	IC				NJM12902V(TE1)	G1093592		1-	B	b6
Q 3011	TRANSISTOR				DTC144EE TL	G3070075		1-	B	a6
Q 3012	IC				M62364FP 600D	G1093033		1-	B	c6
Q 3013	TRANSISTOR				DTC144EE TL	G3070075		1-	B	a5
Q 3014	TRANSISTOR				DTC144EE TL	G3070075		1-	B	a5
Q 3015	TRANSISTOR				DTC144EE TL	G3070075		1-	B	a6
Q 3016	FET				2SJ364-R(TX)	G3703648R		1-	B	b4
Q 3017	IC				NJU7007F2-TE1	G1093617		1-	B	c5
Q 3018	IC				NJM3403AV(TE1)	G1092215		1-	B	a3
Q 3019	TRANSISTOR				DTC144EE TL	G3070075		1-	B	b3
Q 3020	IC				NJM12902V(TE1)	G1093592		1-	B	c6
Q 3021	FET				2SJ364-R(TX)	G3703648R		1-	B	b3
Q 3022	FET				2SJ364-R(TX)	G3703648R		1-	B	b3
Q 3023	TRANSISTOR				2SC4154-T11-1E	G3341548E		1-	B	d3
Q 3024	IC				TAR5S30(TE85L)	G1093570		1-	B	c4
Q 3025	IC				NJU7231F30(TE1)	G1093512		1-	B	c4
Q 3026	IC				S-80830CNMC-B8P-T2	G1093618		1-	B	c4
Q 3027	IC				S-80830CNMC-B8P-T2	G1093618		1-	B	c4
Q 3028	IC				RH5RH651A-T1	G1092598		1-	B	b3
Q 3029	TRANSISTOR				KRX202U-RTK	G3070277		1-	B	b6
Q 3030	IC				NJM2904V-TE1	G1091677		1-	B	b3
Q 3034	IC				AT24C128N-10SI-2.7	G1093516		1-	B	c5
Q 3035	IC				HD6472237TF10 R0663	G1093748	USA	1-	B	b2
Q 3036	TRANSISTOR				DTC144EE TL	G3070075		1-	B	b3
Q 3037	TRANSISTOR				DTC143ZE TL	G3070102		1-	A	C2
Q 3038	TRANSISTOR				2SC5374-TL	G3353748		1-	B	a2
Q 3039	TRANSISTOR				CPH6102-TL	G3070223		1-	B	c5
Q 3040	TRANSISTOR				2SD1801S-TL	G3418018S		1-	B	a3
Q 3041	TRANSISTOR				UMW1 TR	G3070078		1-	B	c5
Q 3042	TRANSISTOR				DTC124EE TL	G3070109		1-	B	b3
Q 3043	TRANSISTOR				2SC4154-T11-1E	G3341548E		1-	B	b5
Q 3044	IC				S-35L12AEFS-TB	G1093558		1-	B	c1
R 3001	CHIP RES.	4.7	1/16W	5%	RMC1/16S 4R7JTH	J24189066		1-	A	B2
R 3002	CHIP RES.	4.7	1/16W	5%	RMC1/16S 4R7JTH	J24189066		1-	A	C2
R 3003	CHIP RES.	47	1/4W	5%	RMC1/4 470JATP	J24245470		1-	A	D3
R 3004	CHIP RES.	1k	1/16W	5%	RMC1/16S 102JTH	J24189025		1-	A	D4
R 3005	CHIP RES.	2.2k	1/16W	5%	RMC1/16S 222JTH	J24189029		1-	B	a3
R 3006	CHIP RES.	0	1/16W	5%	RMC1/16S JPTH	J24189070		1-	B	a3
R 3007	CHIP RES.	10	1/16W	5%	RMC1/16S 100JTH	J24189001		1-	A	C2
R 3008	CHIP RES.	10	1/16W	5%	RMC1/16S 100JTH	J24189001		1-	A	B2
R 3009	CHIP RES.	10	1/16W	5%	RMC1/16S 100JTH	J24189001		1-	A	B2
R 3010	CHIP RES.	10	1/16W	5%	RMC1/16S 100JTH	J24189001		1-	A	B2
R 3011	CHIP RES.	10	1/16W	5%	RMC1/16S 100JTH	J24189001		1-	A	B2
R 3012	CHIP RES.	10	1/16W	5%	RMC1/16S 100JTH	J24189001		1-	A	B2
R 3013	CHIP RES.	220	1/16W	5%	RMC1/16S 221JTH	J24189017		1-	A	B2
R 3014	CHIP RES.	47	1/4W	5%	RMC1/4 470JATP	J24245470		1-	A	D3
R 3015	CHIP RES.	1k	1/16W	5%	RMC1/16S 102JTH	J24189025		1-	A	D4
R 3016	CHIP RES.	12	1/4W	5%	RMC1/4 120JATP	J24245120		1-	A	A2
R 3017	CHIP RES.	47	1/4W	5%	RMC1/4 470JATP	J24245470		1-	A	C3
R 3018	CHIP RES.	1k	1/16W	5%	RMC1/16S 102JTH	J24189025		1-	A	C4
R 3019	CHIP RES.	560k	1/16W	5%	RMC1/16S 564JTH	J24189058		1-	B	a5
R 3020	CHIP RES.	10k	1/16W	5%	RMC1/16S 103JTH	J24189037		1-	B	a5
R 3021	CHIP RES.	15k	1/16W	5%	RMC1/16S 153JTH	J24189039		1-	B	a5
R 3022	CHIP RES.	680	1/16W	5%	RMC1/16S 681JTH	J24189023		1-	B	a5
R 3023	CHIP RES.	150k	1/16W	5%	RMC1/16S 154JTH	J24189051		1-	B	a5
R 3024	CHIP RES.	8.2k	1/16W	5%	RMC1/16S 822JTH	J24189036		1-	B	a5
R 3025	CHIP RES.	47k	1/16W	5%	RMC1/16S 473JTH	J24189045		1-	B	a5

REF.	DESCRIPTION	VALUE	V/W	TOL.	MFR'S DESIG	VXSTD P/N	VERS.	LOT.	SIDE	LAY ADR.
R 3026	CHIP RES.	47k	1/16W	5%	RMC1/16S 473JTH	J24189045		1-	B	a5
R 3027	CHIP RES.	68k	1/16W	5%	RMC1/16S 683JTH	J24189047		1-	B	a6
R 3028	CHIP RES.	33k	1/16W	5%	RMC1/16S 333JTH	J24189043		1-	B	a5
R 3029	CHIP RES.	47k	1/16W	5%	RMC1/16S 473JTH	J24189045		1-	B	a5
R 3030	CHIP RES.	10k	1/16W	5%	RMC1/16S 103JTH	J24189037		1-	B	a5
R 3031	CHIP RES.	5.6k	1/16W	5%	RMC1/16S 562JTH	J24189034		1-	B	a3
R 3032	CHIP RES.	22k	1/16W	5%	RMC1/16S 223JTH	J24189041		1-	B	a3
R 3033	CHIP RES.	47k	1/16W	5%	RMC1/16S 473JTH	J24189045		1-	B	a3
R 3034	CHIP RES.	390k	1/16W	5%	RMC1/16S 394JTH	J24189056		1-	B	a3
R 3035	CHIP RES.	2.2k	1/16W	5%	RMC1/16S 222JTH	J24189029		1-	B	a3
R 3036	CHIP RES.	470	1/16W	5%	RMC1/16S 471JTH	J24189021		1-	B	a3
R 3037	CHIP RES.	470k	1/16W	5%	RMC1/16S 474JTH	J24189057		1-	B	b6
R 3038	CHIP RES.	470k	1/16W	5%	RMC1/16S 474JTH	J24189057		1-	B	b6
R 3039	CHIP RES.	330k	1/16W	5%	RMC1/16S 334JTH	J24189055		1-	B	b6
R 3040	CHIP RES.	330k	1/16W	5%	RMC1/16S 334JTH	J24189055		1-	B	b6
R 3041	CHIP RES.	100	1/16W	5%	RMC1/16S 101JTH	J24189013		1-	B	c6
R 3042	CHIP RES.	100	1/16W	5%	RMC1/16S 101JTH	J24189013		1-	B	c6
R 3043	CHIP RES.	100	1/16W	5%	RMC1/16S 101JTH	J24189013		1-	B	c6
R 3044	CHIP RES.	100	1/16W	5%	RMC1/16S 101JTH	J24189013		1-	B	c6
R 3045	CHIP RES.	470k	1/16W	5%	RMC1/16S 474JTH	J24189057		1-	B	c6
R 3046	CHIP RES.	470k	1/16W	5%	RMC1/16S 474JTH	J24189057		1-	B	c5
R 3047	CHIP RES.	470k	1/16W	5%	RMC1/16S 474JTH	J24189057		1-	B	b6
R 3048	CHIP RES.	330k	1/16W	5%	RMC1/16S 334JTH	J24189055		1-	B	b6
R 3049	CHIP RES.	330k	1/16W	5%	RMC1/16S 334JTH	J24189055		1-	B	b6
R 3050	CHIP RES.	330k	1/16W	5%	RMC1/16S 334JTH	J24189055		1-	B	b5
R 3051	CHIP RES.	330k	1/16W	5%	RMC1/16S 334JTH	J24189055		1-	B	b5
R 3052	CHIP RES.	470k	1/16W	5%	RMC1/16S 474JTH	J24189057		1-	B	b5
R 3053	CHIP RES.	470k	1/16W	5%	RMC1/16S 474JTH	J24189057		1-	B	b5
R 3054	CHIP RES.	470k	1/16W	5%	RMC1/16S 474JTH	J24189057		1-	B	b5
R 3055	CHIP RES.	330k	1/16W	5%	RMC1/16S 334JTH	J24189055		1-	B	b5
R 3056	CHIP RES.	330k	1/16W	5%	RMC1/16S 334JTH	J24189055		1-	B	b5
R 3057	CHIP RES.	10k	1/16W	5%	RMC1/16S 103JTH	J24189037		1-	B	a5
R 3058	CHIP RES.	390k	1/16W	5%	RMC1/16S 394JTH	J24189056		1-	B	a6
R 3059	CHIP RES.	390k	1/16W	5%	RMC1/16S 394JTH	J24189056		1-	B	a6
R 3060	CHIP RES.	10k	1/16W	5%	RMC1/16S 103JTH	J24189037		1-	B	a5
R 3061	CHIP RES.	68k	1/16W	5%	RMC1/16S 683JTH	J24189047		1-	B	a6
R 3062	CHIP RES.	47k	1/16W	5%	RMC1/16S 473JTH	J24189045		1-	B	a5
R 3063	CHIP RES.	390k	1/16W	5%	RMC1/16S 394JTH	J24189056		1-	B	a6
R 3064	CHIP RES.	10k	1/16W	5%	RMC1/16S 103JTH	J24189037		1-	B	a3
R 3065	CHIP RES.	10k	1/16W	5%	RMC1/16S 103JTH	J24189037		1-	B	a3
R 3066	CHIP RES.	47k	1/16W	5%	RMC1/16S 473JTH	J24189045		1-	B	a4
R 3067	CHIP RES.	47k	1/16W	5%	RMC1/16S 473JTH	J24189045		1-	B	a4
R 3068	CHIP RES.	180k	1/16W	5%	RMC1/16S 184JTH	J24189052		1-	B	a4
R 3069	CHIP RES.	270k	1/16W	5%	RMC1/16S 274JTH	J24189054		1-	B	a4
R 3070	CHIP RES.	270k	1/16W	5%	RMC1/16S 274JTH	J24189054		1-	B	a4
R 3071	CHIP RES.	5.6k	1/16W	5%	RMC1/16S 562JTH	J24189034		1-	B	a4
R 3072	CHIP RES.	100k	1/16W	5%	RMC1/16S 104JTH	J24189049		1-	B	a3
R 3073	CHIP RES.	33k	1/16W	5%	RMC1/16S 333JTH	J24189043		1-	B	a4
R 3074	CHIP RES.	10k	1/16W	5%	RMC1/16S 103JTH	J24189037		1-	B	b4
R 3075	CHIP RES.	100	1/16W	5%	RMC1/16S 101JTH	J24189013		1-	B	c6
R 3076	CHIP RES.	100	1/16W	5%	RMC1/16S 101JTH	J24189013		1-	B	c6
R 3077	CHIP RES.	100	1/16W	5%	RMC1/16S 101JTH	J24189013		1-	B	c6
R 3079	CHIP RES.	330k	1/16W	5%	RMC1/16S 334JTH	J24189055		1-	B	c6
R 3080	CHIP RES.	330k	1/16W	5%	RMC1/16S 334JTH	J24189055		1-	B	c6
R 3081	CHIP RES.	470k	1/16W	5%	RMC1/16S 474JTH	J24189057		1-	B	c6
R 3082	CHIP RES.	270k	1/16W	5%	RMC1/16S 274JTH	J24189054		1-	B	a3
R 3083	CHIP RES.	390k	1/16W	5%	RMC1/16S 394JTH	J24189056		1-	B	d5
R 3084	CHIP RES.	470k	1/16W	5%	RMC1/16S 474JTH	J24189057		1-	B	c5
R 3085	CHIP RES.	220k	1/16W	5%	RMC1/16S 224JTH	J24189053		1-	B	c6
R 3086	CHIP RES.	270k	1/16W	5%	RMC1/16S 274JTH	J24189054		1-	B	d5

# CNTL Unit

REF.	DESCRIPTION	VALUE	V/W	TOL.	MFR'S DESIG	VXSTD P/N	VERS.	LOT.	SIDE	LAY ADR.
R 3087	CHIP RES.	47k	1/16W	5%	RMC1/16S 473JTH	J24189045		1-	B	b6
R 3088	CHIP RES.	100k	1/16W	5%	RMC1/16S 104JTH	J24189049		1-	B	a3
R 3088	CHIP RES.	100k	1/16W	0.50%	RR0510R-104-D	J24189167		2-	B	a3
R 3089	CHIP RES.	330k	1/16W	5%	RMC1/16S 334JTH	J24189055		1-	B	c5
R 3090	CHIP RES.	1M	1/16W	5%	RMC1/16S 105JTH	J24189061		1-	B	d5
R 3091	CHIP RES.	10k	1/16W	5%	RMC1/16S 103JTH	J24189037		1-	B	c5
R 3092	CHIP RES.	390k	1/16W	5%	RMC1/16S 394JTH	J24189056		1-	B	a6
R 3093	CHIP RES.	10k	1/16W	5%	RMC1/16S 103JTH	J24189037		1-	B	a6
R 3094	CHIP RES.	120k	1/16W	5%	RMC1/16S 124JTH	J24189050		1-	B	a6
R 3095	CHIP RES.	5.6k	1/16W	5%	RMC1/16S 562JTH	J24189034		1-	B	a4
R 3096	CHIP RES.	4.7k	1/16W	5%	RMC1/16S 472JTH	J24189033		1-	B	a4
R 3097	CHIP RES.	2.2k	1/16W	5%	RMC1/16S 222JTH	J24189029		1-	B	a3
R 3098	CHIP RES.	4.7k	1/16W	5%	RMC1/16S 472JTH	J24189033		1-	B	a3
R 3099	CHIP RES.	330k	1/16W	5%	RMC1/16S 334JTH	J24189055		1-	B	b4
R 3100	CHIP RES.	330k	1/16W	5%	RMC1/16S 334JTH	J24189055		1-	B	b4
R 3101	CHIP RES.	0	1/16W	5%	RMC1/16S JPTH	J24189070		1-	B	b4
R 3102	CHIP RES.	0	1/16W	5%	RMC1/16S JPTH	J24189070		1-	B	b4
R 3103	CHIP RES.	470k	1/16W	5%	RMC1/16S 474JTH	J24189057		1-	B	a4
R 3104	CHIP RES.	47k	1/16W	5%	RMC1/16S 473JTH	J24189045		1-	B	b4
R 3105	CHIP RES.	3.3M	1/16W	5%	RMC1/16S 335JTH	J24189324		1-	B	d5
R 3106	CHIP RES.	150k	1/16W	5%	RMC1/16S 154JTH	J24189051		1-	B	d5
R 3107	CHIP RES.	47k	1/16W	5%	RMC1/16S 473JTH	J24189045		1-	B	a5
R 3108	CHIP RES.	10k	1/16W	5%	RMC1/16S 103JTH	J24189037		1-	B	a5
R 3109	CHIP RES.	10k	1/16W	5%	RMC1/16S 103JTH	J24189037		1-	B	a6
R 3110	CHIP RES.	10k	1/16W	5%	RMC1/16S 103JTH	J24189037		1-	B	a4
R 3111	CHIP RES.	4.7k	1/16W	5%	RMC1/16S 472JTH	J24189033		1-	B	a3
R 3112	CHIP RES.	10k	1/16W	5%	RMC1/16S 103JTH	J24189037		1-	B	b3
R 3113	CHIP RES.	10k	1/16W	5%	RMC1/16S 103JTH	J24189037		1-	B	b3
R 3114	CHIP RES.	10k	1/16W	5%	RMC1/16S 103JTH	J24189037		1-	B	b3
R 3115	CHIP RES.	22k	1/16W	5%	RMC1/16S 223JTH	J24189041		1-	B	b3
R 3116	CHIP RES.	330k	1/16W	5%	RMC1/16S 334JTH	J24189055		1-	B	b3
R 3118	CHIP RES.	10k	1/16W	5%	RMC1/16S 103JTH	J24189037		1-	B	b3
R 3119	CHIP RES.	10k	1/16W	5%	RMC1/16S 103JTH	J24189037		1-	B	b3
R 3120	CHIP RES.	15k	1/16W	5%	RMC1/16S 153JTH	J24189039		1-	B	c4
R 3121	CHIP RES.	390k	1/16W	5%	RMC1/16S 394JTH	J24189056		1-	B	d4
R 3122	CHIP RES.	100k	1/16W	5%	RMC1/16S 104JTH	J24189049		1-	B	b6
R 3123	CHIP RES.	1M	1/16W	5%	RMC1/16S 105JTH	J24189061		1-	B	a4
R 3124	CHIP RES.	330k	1/16W	5%	RMC1/16S 334JTH	J24189055		1-	B	a3
R 3125	CHIP RES.	22k	1/16W	5%	RMC1/16S 223JTH	J24189041		1-	B	c4
R 3126	CHIP RES.	22k	1/16W	5%	RMC1/16S 223JTH	J24189041		1-	B	c3
R 3127	CHIP RES.	82k	1/16W	5%	RMC1/16S 823JTH	J24189048		1-	B	c4
R 3128	CHIP RES.	150k	1/16W	5%	RMC1/16S 154JTH	J24189051		1-	B	c4
R 3129	CHIP RES.	2.2	1/16W	5%	RMC1/16 2R2JATP	J24185229		1-	B	b3
R 3131	CHIP RES.	100	1/16W	5%	RMC1/16S 101JTH	J24189013		1-	B	b6
R 3132	CHIP RES.	4.7k	1/16W	5%	RMC1/16S 472JTH	J24189033		1-	B	b6
R 3133	CHIP RES.	1k	1/16W	5%	RMC1/16S 102JTH	J24189025		1-	B	c1
R 3134	CHIP RES.	1M	1/16W	5%	RMC1/16S 105JTH	J24189061		1-	B	a4
R 3137	CHIP RES.	4.7	1/16W	5%	RMC1/16S 4R7JTH	J24189066		1-	B	c3
R 3138	CHIP RES.	22k	1/16W	5%	RMC1/16S 223JTH	J24189041		1-	B	b3
R 3139	CHIP RES.	22k	1/16W	5%	RMC1/16S 223JTH	J24189041		1-	B	b3
R 3140	CHIP RES.	100k	1/16W	5%	RMC1/16S 104JTH	J24189049		1-	B	b3
R 3141	CHIP RES.	68k	1/16W	0.50%	RR0510R-683-D	J24189163		1-	B	b2
R 3142	CHIP RES.	33k	1/16W	5%	RMC1/16S 333JTH	J24189043		1-	A	C2
R 3143	CHIP RES.	100k	1/16W	5%	RMC1/16S 104JTH	J24189049		1-	A	C2
R 3144	CHIP RES.	1M	1/16W	5%	RMC1/16S 105JTH	J24189061		1-	B	a1
R 3145	CHIP RES.	2.2k	1/16W	5%	RMC1/16S 222JTH	J24189029		1-	B	a2
R 3146	CHIP RES.	100k	1/16W	0.50%	RR0510R-104-D	J24189167		1-	B	b2
R 3147	CHIP RES.	100k	1/16W	0.50%	RR0510R-104-D	J24189167		1-	B	b2
R 3148	CHIP RES.	100k	1/16W	0.50%	RR0510R-104-D	J24189167		1-	B	b2
R 3149	CHIP RES.	100k	1/16W	0.50%	RR0510R-104-D	J24189167		1-	B	a2

# CNTL Unit

REF.	DESCRIPTION	VALUE	V/W	TOL.	MFR'S DESIG	VXSTD P/N	VERS.	LOT.	SIDE	LAY ADR.
R 3150	CHIP RES.	1M	1/16W	5%	RMC1/16S 105JTH	J24189061		1-	B	c5
R 3151	CHIP RES.	47k	1/16W	5%	RMC1/16S 473JTH	J24189045		1-	B	b2
R 3152	CHIP RES.	22k	1/16W	5%	RMC1/16S 223JTH	J24189041		1-	B	c4
R 3153	CHIP RES.	22k	1/16W	5%	RMC1/16S 223JTH	J24189041		1-	B	c4
R 3154	CHIP RES.	4.7	1/2W	5%	RMC1/2 4R7JCTP	J24275479		1-	B	a3
R 3155	CHIP RES.	4.7k	1/16W	5%	RMC1/16S 472JTH	J24189033		1-	B	b2
R 3156	CHIP RES.	2.7k	1/16W	5%	RMC1/16S 272JTH	J24189030		1-	B	c5
R 3157	CHIP RES.	4.7k	1/16W	5%	RMC1/16S 472JTH	J24189033		1-	B	b2
R 3158	CHIP RES.	47k	1/16W	5%	RMC1/16S 473JTH	J24189045		1-	B	b5
R 3159	CHIP RES.	47k	1/16W	5%	RMC1/16S 473JTH	J24189045		1-	B	b6
R 3160	CHIP RES.	100k	1/16W	5%	RMC1/16S 104JTH	J24189049		1-	B	c1
R 3161	CHIP RES.	100k	1/16W	5%	RMC1/16S 104JTH	J24189049		1-	B	c1
R 3162	CHIP RES.	100k	1/16W	5%	RMC1/16S 104JTH	J24189049		1-	B	c1
R 3167	CHIP RES.	10	1/16W	5%	RMC1/16S 100JTH	J24189001		1-	A	B2
R 3168	CHIP RES.	100k	1/16W	5%	RMC1/16S 104JTH	J24189049		1-	B	b4
R 3169	CHIP RES.	100k	1/16W	5%	RMC1/16S 104JTH	J24189049		1-	B	c2
R 3170	CHIP RES.	2.2k	1/16W	5%	RMC1/16S 222JTH	J24189029		1-	B	c4
R 3171	CHIP RES.	22k	1/16W	5%	RMC1/16S 223JTH	J24189041		1-	B	d6
R 3172	CHIP RES.	47k	1/16W	5%	RMC1/16S 473JTH	J24189045		1-	B	a5
TH3001	THERMISTOR				ERTJ1VV473J	G9090122		1-	B	a2
X 3001	XTAL VT-200	32.768KHz			20PPM/6PF	H0103267		1-	B	c1
X 3002	XTAL SX-1319	3.579545MHz			3.579545MHZ	H0103229		1-	B	a1
	MIC HOLDER RUBBER					RA0405600		1-		
	REFLECTOR SHEET					RA0399900		1-		
	DOUBLE FACE				(LCD)	RA014250A		1-		
	LIGHT GUIDE				(LCD)	RA0399100		1-		

**CNTL Unit**  
**Note:**



## Circuit Diagram

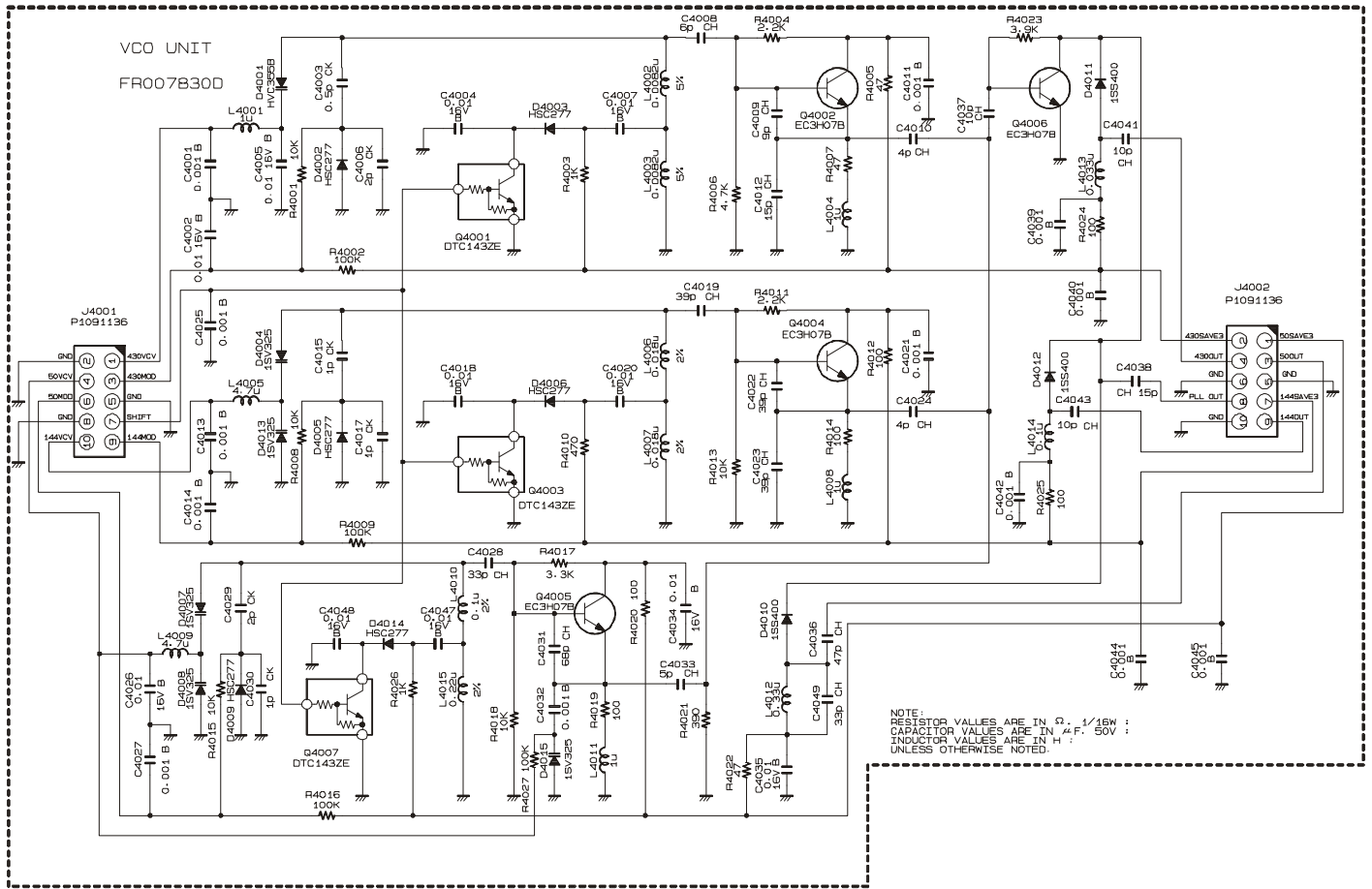

## Parts Layout

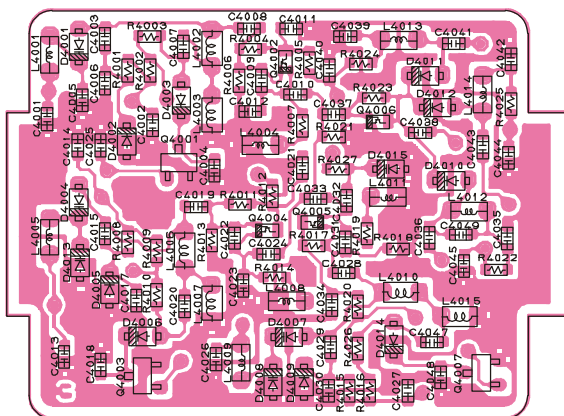

Side A

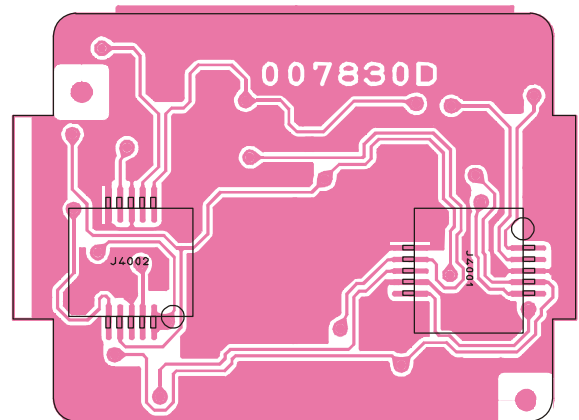

Side B

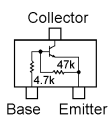

DTC143ZE (E23)  
(Q4001, 4003, 4007)

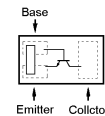

EC3H07B (G)  
(Q4002, 4004, 4005,  
4006)

**VCO Unit**  
**Note**

## Parts List

REF.	DESCRIPTION	VALUE	V/W	TOL.	MFR'S DESIG	VXSTD P/N	VERS.	LOT.	SIDE	LAY ADR.
PCB with Components						CB1872001				
Printed Circuit Board						FR007830D		1-		
C 4001	CHIP CAP.	0.001uF	50V	B	UMK105B102KW-F	K22178829		1-	A	
C 4002	CHIP CAP.	0.01uF	16V	B	GRM36B103K16PT	K22128804		1-	A	
C 4003	CHIP CAP.	0.5pF	50V	CK	UMK105CK0R5CW-F	K22178247		1-	A	
C 4004	CHIP CAP.	0.01uF	16V	B	GRM36B103K16PT	K22128804		1-	A	
C 4005	CHIP CAP.	0.01uF	16V	B	GRM36B103K16PT	K22128804		1-	A	
C 4006	CHIP CAP.	2pF	50V	CK	UMK105CK020CW-F	K22178250		1-	A	
C 4007	CHIP CAP.	0.01uF	16V	B	GRM36B103K16PT	K22128804		1-	A	
C 4008	CHIP CAP.	6pF	50V	CH	GRM36CH060B50PT	K22178293		1-	A	
C 4009	CHIP CAP.	7pF	50V	CH	GRM36CH070B50PT	K22178294		1-	A	
C 4010	CHIP CAP.	4pF	50V	CH	UMK105CH040CW-F	K22178252		1-	A	
C 4011	CHIP CAP.	0.001uF	50V	B	UMK105B102KW-F	K22178829		1-	A	
C 4012	CHIP CAP.	15pF	50V	CH	UMK105CH150JW-F	K22178262		1-	A	
C 4013	CHIP CAP.	0.001uF	50V	B	UMK105B102KW-F	K22178829		1-	A	
C 4014	CHIP CAP.	0.001uF	50V	B	UMK105B102KW-F	K22178829		1-	A	
C 4015	CHIP CAP.	1pF	50V	CK	UMK105CK010CW-F	K22178248		1-	A	
C 4017	CHIP CAP.	1pF	50V	CK	UMK105CK010CW-F	K22178248		1-	A	
C 4018	CHIP CAP.	0.01uF	16V	B	GRM36B103K16PT	K22128804		1-	A	
C 4019	CHIP CAP.	39pF	50V	CH	UMK105CH390JW-F	K22178272		1-	A	
C 4020	CHIP CAP.	0.01uF	16V	B	GRM36B103K16PT	K22128804		1-	A	
C 4021	CHIP CAP.	0.001uF	50V	B	UMK105B102KW-F	K22178829		1-	A	
C 4022	CHIP CAP.	39pF	50V	CH	UMK105CH390JW-F	K22178272		1-	A	
C 4023	CHIP CAP.	39pF	50V	CH	UMK105CH390JW-F	K22178272		1-	A	
C 4024	CHIP CAP.	4pF	50V	CH	UMK105CH040CW-F	K22178252		1-	A	
C 4025	CHIP CAP.	0.001uF	50V	B	UMK105B102KW-F	K22178829		1-	A	
C 4026	CHIP CAP.	0.01uF	16V	B	GRM36B103K16PT	K22128804		1-	A	
C 4027	CHIP CAP.	0.001uF	50V	B	UMK105B102KW-F	K22178829		1-	A	
C 4028	CHIP CAP.	33pF	50V	CH	UMK105CH330JW-F	K22178270		1-	A	
C 4029	CHIP CAP.	2pF	50V	CK	UMK105CK020CW-F	K22178250		1-	A	
C 4030	CHIP CAP.	1pF	50V	CK	UMK105CK010CW-F	K22178248		1-	A	
C 4031	CHIP CAP.	68pF	50V	CH	UMK105CH680JW-F	K22178278		1-	A	
C 4032	CHIP CAP.	0.001uF	50V	B	UMK105B102KW-F	K22178829		1-	A	
C 4033	CHIP CAP.	5pF	50V	CH	UMK105CH050CW-F	K22178253		1-	A	
C 4034	CHIP CAP.	0.01uF	16V	B	GRM36B103K16PT	K22128804		1-	A	
C 4035	CHIP CAP.	0.01uF	16V	B	GRM36B103K16PT	K22128804		1-	A	
C 4036	CHIP CAP.	47pF	50V	CH	UMK105CH470JW-F	K22178274		1-	A	
C 4037	CHIP CAP.	10pF	50V	CH	UMK105CH100DW-F	K22178258		1-	A	
C 4038	CHIP CAP.	15pF	50V	CH	UMK105CH150JW-F	K22178262		1-	A	
C 4039	CHIP CAP.	0.001uF	50V	B	UMK105B102KW-F	K22178829		1-	A	
C 4040	CHIP CAP.	0.001uF	50V	B	UMK105B102KW-F	K22178829		1-	A	
C 4041	CHIP CAP.	10pF	50V	CH	UMK105CH100DW-F	K22178258		1-	A	
C 4042	CHIP CAP.	0.001uF	50V	B	UMK105B102KW-F	K22178829		1-	A	
C 4043	CHIP CAP.	10pF	50V	CH	UMK105CH100DW-F	K22178258		1-	A	
C 4044	CHIP CAP.	0.001uF	50V	B	UMK105B102KW-F	K22178829		1-	A	
C 4045	CHIP CAP.	0.001uF	50V	B	UMK105B102KW-F	K22178829		1-	A	
C 4047	CHIP CAP.	0.01uF	16V	B	GRM36B103K16PT	K22128804		1-	A	
C 4048	CHIP CAP.	0.01uF	16V	B	GRM36B103K16PT	K22128804		1-	A	
C 4049	CHIP CAP.	33pF	50V	CH	UMK105CH330JW-F	K22178270		1-	A	
D 4001	DIODE				HVC355B(TAPE)	G2070588		1-	A	
D 4002	DIODE				HSC277TRF	G2070584		1-	A	
D 4003	DIODE				HSC277TRF	G2070584		1-	A	
D 4004	DIODE				1SV325(TPH3)	G2070848		1-	A	
D 4005	DIODE				HSC277TRF	G2070584		1-	A	
D 4006	DIODE				HSC277TRF	G2070584		1-	A	
D 4007	DIODE				1SV325(TPH3)	G2070848		1-	A	
D 4008	DIODE				1SV325(TPH3)	G2070848		1-	A	
D 4009	DIODE				HSC277TRF	G2070584		1-	A	
D 4010	DIODE				1SS400 TE61	G2070634		1-	A	
D 4011	DIODE				1SS400 TE61	G2070634		1-	A	

# VCO Unit

REF.	DESCRIPTION	VALUE	V/W	TOL.	MFR'S DESIG	VXSTD P/N	VERS.	LOT.	SIDE	LAY ADR.
D 4012	DIODE				1SS400 TE61	G2070634		1-	A	
D 4013	DIODE				1SV325(TPH3)	G2070848		1-	A	
D 4014	DIODE				HSC277TRF	G2070584		1-	A	
D 4015	DIODE				1SV325(TPH3)	G2070848		1-	A	
J 4001	CONNECTOR				AXK5F10335P	P1091136		1-	B	
J 4002	CONNECTOR				AXK5F10335P	P1091136		1-	B	
L 4001	M.RFC	1uH			LK1608 1R0K-T	L1690687		1-	A	
L 4002	M.RFC	0.0082uH		5%	C1608CA-8N2J	L1691095		1-	A	
L 4003	M.RFC	0.0082uH		5%	C1608CA-8N2J	L1691095		1-	A	
L 4004	M.RFC	1uH			LK1608 1R0K-T	L1690687		1-	A	
L 4005	M.RFC	4.7uH			LK1608 4R7K-T	L1690688		1-	A	
L 4006	M.RFC	0.018uH		2%	C1608CA-18NG	L1691035		1-	A	
L 4007	M.RFC	0.018uH		2%	C1608CA-18NG	L1691035		1-	A	
L 4008	M.RFC	1uH			LK1608 1R0K-T	L1690687		1-	A	
L 4009	M.RFC	4.7uH			LK1608 4R7K-T	L1690688		1-	A	
L 4010	M.RFC	0.1uH		2%	C1608CA-R10G	L1691045		1-	A	
L 4011	M.RFC	1uH			LK1608 1R0K-T	L1690687		1-	A	
L 4012	M.RFC	0.33uH			LK1608 R33K-T	L1690412		1-	A	
L 4013	M.RFC	0.033uH			HK1608 33NJ-T	L1690522		1-	A	
L 4014	M.RFC	0.1uH			LK1608 R10K-T	L1690407		1-	A	
L 4015	M.RFC	0.22uH		2%	C1608CA-R22G	L1691103		1-	A	
Q 4001	TRANSISTOR				DTC143ZE TL	G3070102		1-	A	
Q 4002	TRANSISTOR				EC3H07B-TL	G3070286		1-	A	
Q 4003	TRANSISTOR				DTC143ZE TL	G3070102		1-	A	
Q 4004	TRANSISTOR				EC3H07B-TL	G3070286		1-	A	
Q 4005	TRANSISTOR				EC3H07B-TL	G3070286		1-	A	
Q 4006	TRANSISTOR				EC3H07B-TL	G3070286		1-	A	
Q 4007	TRANSISTOR				DTC143ZE TL	G3070102		1-	A	
R 4001	CHIP RES.	10k	1/16W	5%	RMC1/16S 103JTH	J24189037		1-	A	
R 4002	CHIP RES.	100k	1/16W	5%	RMC1/16S 104JTH	J24189049		1-	A	
R 4003	CHIP RES.	470	1/16W	5%	RMC1/16S 471JTH	J24189021		1-	A	
R 4004	CHIP RES.	2.2k	1/16W	5%	RMC1/16S 222JTH	J24189029		1-	A	
R 4005	CHIP RES.	47	1/16W	5%	RMC1/16S 470JTH	J24189009		1-	A	
R 4006	CHIP RES.	4.7k	1/16W	5%	RMC1/16S 472JTH	J24189033		1-	A	
R 4007	CHIP RES.	47	1/16W	5%	RMC1/16S 470JTH	J24189009		1-	A	
R 4008	CHIP RES.	10k	1/16W	5%	RMC1/16S 103JTH	J24189037		1-	A	
R 4009	CHIP RES.	100k	1/16W	5%	RMC1/16S 104JTH	J24189049		1-	A	
R 4010	CHIP RES.	470	1/16W	5%	RMC1/16S 471JTH	J24189021		1-	A	
R 4011	CHIP RES.	2.2k	1/16W	5%	RMC1/16S 222JTH	J24189029		1-	A	
R 4012	CHIP RES.	100	1/16W	5%	RMC1/16S 101JTH	J24189013		1-	A	
R 4013	CHIP RES.	10k	1/16W	5%	RMC1/16S 103JTH	J24189037		1-	A	
R 4014	CHIP RES.	100	1/16W	5%	RMC1/16S 101JTH	J24189013		1-	A	
R 4015	CHIP RES.	10k	1/16W	5%	RMC1/16S 103JTH	J24189037		1-	A	
R 4016	CHIP RES.	100k	1/16W	5%	RMC1/16S 104JTH	J24189049		1-	A	
R 4017	CHIP RES.	3.3k	1/16W	5%	RMC1/16S 332JTH	J24189031		1-	A	
R 4018	CHIP RES.	10k	1/16W	5%	RMC1/16S 103JTH	J24189037		1-	A	
R 4019	CHIP RES.	100	1/16W	5%	RMC1/16S 101JTH	J24189013		1-	A	
R 4020	CHIP RES.	100	1/16W	5%	RMC1/16S 101JTH	J24189013		1-	A	
R 4021	CHIP RES.	390	1/16W	5%	RMC1/16S 391JTH	J24189020		1-	A	
R 4022	CHIP RES.	47	1/16W	5%	RMC1/16S 470JTH	J24189009		1-	A	
R 4023	CHIP RES.	3.9k	1/16W	5%	RMC1/16S 392JTH	J24189032		1-	A	
R 4024	CHIP RES.	100	1/16W	5%	RMC1/16S 101JTH	J24189013		1-	A	
R 4025	CHIP RES.	100	1/16W	5%	RMC1/16S 101JTH	J24189013		1-	A	
R 4026	CHIP RES.	1k	1/16W	5%	RMC1/16S 102JTH	J24189025		1-	A	
R 4027	CHIP RES.	100k	1/16W	5%	RMC1/16S 104JTH	J24189049		1-	A	
	SHIELD CASE VCO					RA0400300		1-		

**Note:**



Copyright 2002  
VERTEX STANDARD CO., LTD.  
All rights reserved

No portion of this manual  
may be reproduced without  
the permission of  
VERTEX STANDARD CO., LTD.

Printed in Japan.



E H 0 0 9 M 9 0 0